



Page 4  
Handsome and nostalgic Wings Gauges give your vehicle dashboard flair

Page 5  
Standard Plus Gauges  
NEW packaging makes an attractive shelf



INSTRUMENTS		2-5
DELUXE™ GAUGES		2
HEAVY DUTY™ GAUGES		2
HEAVY DUTY PLUS™ GAUGES		3
SEAWORTHY™ GAUGES		3
WINGS™ GAUGES		4
TRACK FORCE™ GAUGES		4
STANDARD & STANDARD PLUS™ GAUGES		5
WORLD WIDE™ GAUGES		5



Page 6



Page 10

MECHANICAL INSTRUMENTS		6-11
PRESSURE		6, 7
TEMPERATURE		8
VACUUM		9
TURBO		9
AIR RESTRICTION		9
SPEEDOMETERS		10
TACHOMETERS		11



Page 12



Page 16

ELECTRIC INSTRUMENTS		12
TACHOMETERS		12, 13
SPEEDOMETERS		14
PYROMETERS		14
TEMPERATURE		15
PRESSURE		16, 17
VOLTMETERS		17
AMMETERS		18
FUEL LEVEL		19
BOW TRIM		19
COMMANDER SERIES 24 VOLT LINE		20
STEWART WARNER DC HOURMETERS		21



Page 18



Page 19

**OTHER STEWART WARNER PRODUCTS**

THICK FILM FUEL / PRESSURE SENDERS	22, 23	MOUNTING PANELS	32	IGNITION SWITCH	40
TEMP SENDER, TEMP SWITCHES & PRESS SWITCHES	24	PEDESTAL TACHOMETERS	33	BULK CORE AND CASING AND SPECIAL TOOLS	41
HOBBS PRESSURE & VACUUM SWITCHES	25	BOX KITS & PANELS	34, 35	END TIPS	42
HOBBS DC HOURMETERS	26	5" GAUGE CLUSTER	35	FERRULES AND NUTS	43
HOBBS AC HOURMETERS	27	STANDARD PLUS	36	777 SERIES DRIVE JOINT KITS AND PARTS	44
HOBBS HALOGEN LAMPS	28	VOLTAGE ADAPTER	36	666 SERIES DRIVE JOINT KITS AND PARTS	45
HOBBS LIGHTING PRODUCTS	29	REPLACEMENT LIGHT KITS	36	BOX KITS	53
4 GC CLUSTER PANELS & ACCESSORIES	30	TUBE KITS & ADPATER NUTS	37	COUNTER DISPLAYS	53
SPECIALTY INSTRUMENTS	31	ELECTRIC FUEL PUMPS	38		
		TACHOMETER & SPEEDOMETER ACCESSORIES / SHUNTS	39		
		HOBBS FLASHERS / WARNING DEVICES	40		

**TECHNICAL INFORMATION**

PRODUCT DIMENSIONS	46 - 48	MODEL TO SALES KIT NUMBER INTERCHANGE	50 - 51	GAUGE FAMILY REFERENCE	54 - 56
WIRING DIAGRAMS	49	SALES KIT TO MODEL NUMBER INTERCHANGE	51 - 52	INDEX	57 - 59

# MECHANICAL PRESSURE

STEWART WARNER BRAND PRODUCTS



DELUXE (DLX)



HEAVY DUTY (HD)



HEAVY DUTY PLUS (HD+)



SEAWORTHY (SWTHY)

Kit # Figure Family Dial Graphics Characteristic

## 1-10 PSI PRESSURE 2 1/16"

82319 DLX FUEL PRESSURE

## 2-30 PSI MANIFOLD, FUEL, & WATER PRESSURE 2 1/16"

82321	1	DLX	MANIFOLD PRESSURE	
82320	1	DLX	FUEL PRESSURE	
82130	1	DLX	WATER PSI	Marine Deluxe
83030	1	SWTHY	WATER PSI	White Bezel/White Facedial
83031	1	SWTHY	WATER PSI	Red Bezel/White Facedial
83032	1	SWTHY	WATER PSI	Purple Bezel/White Facedial
83033	1	SWTHY	WATER PSI	Blue Bezel/White Facedial
83034	1	SWTHY	WATER PSI	Gray Bezel/White Facedial
83035	1	SWTHY	WATER PSI	Teal Bezel/White Facedial



FIGURE 1

## 0-50 PSI PRESSURE 2 1/32"

82207 1 STD psi PRESSURE Non-illuminated/sealed case



FIGURE 1

## 5-80 PSI OIL PRESSURE 2 1/16"

82322	1	DLX	OIL PRESSURE	
82363	1	HD+	OIL psi	
82475	1	WINGS	OIL PRESS	White Facedial
82476	1	WINGS	OIL PRESS	Black Facedial
82208	2	STD	psi PRESSURE	Non-illuminated/sealed case/2 1/32" case



FIGURE 1



FIGURE 2

## 2-100 PSI AIR SUSPENSION 2 1/16"

82396	1	DLX	AIR SUSPENSION PSI	Waterproof Case/Black Bezel/ Non-illuminated
82483	1	WINGS	AIR SUSPENSION	White Facedial
82484	1	WINGS	AIR SUSPENSION	Black Facedial



FIGURE 1

## 1-15 PSI PRESSURE 2 5/8"

82405 DLX FUEL PRESSURE

## 5-100 PSI OIL PRESSURE 2 1/16"

82323	1	DLX	OIL PRESSURE	
284D	1	HD	OIL PSI	
82372	1	HD+	OIL psi	
82857-P	1	TF	OIL PRESS	Black Bezel
82877-P	1	TF	OIL PRESS	Stainless Steel Bezel
82209	2	STD	psi PRESSURE	Non-illuminated/sealed case/2 1/32" case
82741	3	HD+	psi kPa OIL	Dual Scale/English Dominant
82392	4	DLX	kPa	Metric Deluxe
82704	5	WW	ENGINE OIL PRESS	Dual Scale/English Dominant
			psi kPa	



FIGURE 1



FIGURE 2



FIGURE 3



FIGURE 4

## 5-100 PSI OIL PRESSURE 2 5/8"

82406	1	DLX	OIL PRESSURE	
82807-P	1	TF	OIL PRESS	Black Bezel
82827-P	1	TF	OIL PRESS	Stainless Steel Bezel



FIGURE 5

Tubing Kits See Page 37





WORLD WIDE (WW)



TRACK FORCE (TF)



STANDARD (STD)



WINGS

		Kit #	Figure	Family	Dial Graphics	Characteristic	
<b>10-150 PSI AIR PRESSURE</b> <span style="float: right;"><b>2 1/16"</b></span>							
<p>FIGURE 1</p>	<p>FIGURE 2</p>	82329	1	DLX	AIR PRESSURE		
		82350	1	DLX	AIR PRESSURE		7/16" Thread
<p>FIGURE 3</p>	<p>FIGURE 4</p>	284N	1	HD	AIR PSI		
		82710	2	WW	AIR PRESSURE	psi kPa	Dual Scale/English Dominant
		82373	1	HD+	AIR psi		
		82742	3	HD+	psi AIR	kPa	Dual Scale/English Dominant
		82393	4	DLX	kPa		Metric Deluxe
		82487	1	WINGS	AIR PRESS		White Facedial
		82488	1	WINGS	AIR PRESS		Black Facedial
<b>10-150 PSI PRESSURE</b> <span style="float: right;"><b>2 5/8"</b></span>							
		82407		DLX	OIL PRESSURE		
		82408		DLX	AIR PRESSURE		
<b>10-150 PSI DUAL AIR PRESSURE</b> <span style="float: right;"><b>2 1/16"</b></span>							
<p>FIGURE 1</p>	<p>FIGURE 2</p>	82331	1	HD	AIR PSI		
		82332	1	DLX	AIR PRESSURE		
		82371	1	HD+	AIR psi P	S	
		82746	2	HD+	kPa AIR P	S psi	Dual Scale/English Dominant
<b>10-200 PSI OIL &amp; FUEL PRESSURE</b> <span style="float: right;"><b>2 1/16"</b></span>							
<p>FIGURE 1</p>		82324	1	DLX	OIL PRESSURE		
		82325	1	DLX	FUEL PRESSURE		
		284P	1	HD	OIL PSI		
		82364	1	HD+	OIL psi		
		82858-P	1	TF	OIL PRESS		Black Bezel
		82878-P	1	TF	OIL PRESS		Stainless Steel Bezel
<b>10-200 PSI OIL &amp; PRESSURE</b> <span style="float: right;"><b>2 5/8"</b></span>							
		82808-P	1	TF	OIL PRESS	Black Bezel	
		82828-P	1	TF	OIL PRESS	Stainless Steel Bezel	
<b>20-300 PSI TRANSMISSION OIL &amp; DRIVE OIL PRESSURE</b> <span style="float: right;"><b>2 1/16"</b></span>							
<p>FIGURE 1</p>	<p>FIGURE 2</p>	82120	1	DLX	DRIVE OIL	Marine Deluxe	
		284R	1	HD	TRANS PSI		
<p>FIGURE 3</p>		82365	1	HD+	TRANS psi		
		82717	3	WW	TRANS OIL PRESS		Dual Scale/English Dominant
		82743	2	HD+	psi kPa		Dual Scale/English Dominant
					psi kPa		Dual Scale/English Dominant
<b>25-400 PSI TRANSMISSION OIL &amp; DRIVE OIL PRESSURE</b> <span style="float: right;"><b>2 1/16"</b></span>							
<p>FIGURE 1</p>		82121	1	DLX	DRIVE OIL	Marine Deluxe	
		284S	1	HD	TRANS PSI		
		82380	1	HD+	TRANS psi		
<b>TUBE KITS</b>							
		82553-F				6 FT. Tubing	
		366HM-F				16 FT. Tubing	
		Tubing Kits See Page 37					



STANDARD (STD)



HEAVY DUTY (HD)



HEAVY DUTY PLUS (HD+)



DELUXE (DLX)



FIGURE 1



FIGURE 2

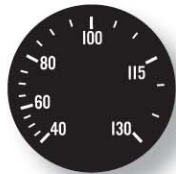

FIGURE 3



FIGURE 4



FIGURE 5



FIGURE 6



FIGURE 7



FIGURE 8

Kit #	Figure	Family	Dial Graphics	Characteristic
<b>100-250°F WATER TEMPERATURE</b> <span style="float: right;"><b>2 1/32"</b></span>				
82210*	5	STD	TEMPERATURE	Sealed Case/Non-illuminated/ Tube Length Inches-36, 48, 60, 72, 144
<b>100-265°F WATER TEMPERATURE</b> <span style="float: right;"><b>2 1/16"</b></span>				
284B*	1	HD	WATER °F	Tube Length Inches-36, 72, 144
491CT*	1	DLX	WATER TEMP	Tube Length Inches-600
82326*	1	DLX	WATER TEMP	Tube Length Inches-48, 60, 72, 96, 120, 144, 216, 288, 360
82381*	1	HD+	WATER °F	Tube Length Inches-36, 72, 144
82394*	3	DLX	°C	Metric Deluxe Tube Length-72, 96, 144
82479*	1	WINGS	WATER TEMP	White Facial/Tube Length Inches-72, 96, 144
82480*	1	WINGS	WATER TEMP	Black Facial/Tube Length Inches-72, 96, 144
82703*	4	WW	WATER TEMP  °F °C	Dual Scale/English Dominant/ Tube Length Inches-72, 144
82744*	2	HD+	COOLANT  °F °C	Dual Scale/English Dominant/ Tube Length Inches-72, 96, 144
82859-P*	1	TF	WATER TEMP	Black Bezel/Tube Length Inches-36, 72, 144
82879-P*	1	TF	WATER TEMP	Stainless Steel Bezel/Tube Length Inches-36, 72, 144
<b>100-265°F WATER TEMPERATURE</b> <span style="float: right;"><b>2 5/8"</b></span>				
82409*	1	DLX	WATER TEMP	Tube Length Inches-60, 72, 144
82809-P*	1	TF	WATER TEMP	Black Bezel/Tube Length Inches-72, 144
82829-P*	1	TF	WATER TEMP	Stainless Steel Bezel/Tube Length Inches-72, 144
<b>140-320°F OIL TEMPERATURE</b> <span style="float: right;"><b>2 1/16"</b></span>				
82749*	6	HD+	OIL  °F °C	Dual Scale/English Dominant/ Tube Length Inches-72, 96, 144
82395*	7	DLX	°C	Metric Deluxe Tube Length-72, 96, 144
<b>140-325°F OIL TEMPERATURE</b> <span style="float: right;"><b>2 1/16"</b></span>				
284C*	8	HD	OIL °F	Tube Length Inches-36, 72, 144
82327*	8	DLX	OIL TEMP	Tube Length Inches-60, 72, 96, 144, 216
82382*	8	HD+	OIL °F	Tube Length Inches-36, 72, 144
82860-P*	8	TF	OIL TEMP	Black Bezel/Tube Length Inches-36, 72, 144
82880-P*	8	TF	OIL TEMP	Stainless Steel Bezel/Tube Length Inches-36, 72, 144
<b>140-325°F OIL TEMPERATURE</b> <span style="float: right;"><b>2 5/8"</b></span>				
82410*	8	DLX	OIL TEMP	Tube Length Inches-60, 72
82810-P*	8	TF	OIL TEMP	Black Bezel/Tube Length Inches-72, 144
82830-P*	8	TF	OIL TEMP	Stainless Steel Bezel/Tube Length Inches-72, 144

**WARNING:** The tubing on mechanical temperature gauges is gas-filled and cannot be shortened without damaging the gauge.

**\*Must indicate tube length when ordering mechanical water temperature and oil temperature gauges, ie; 82326-72.**





**WORLD WIDE (WW)**



**TRACK FORCE (TF)**



**WINGS**



**HEAVY DUTY PLUS (HD+)**



**FIGURE 1**



**FIGURE 2**



**FIGURE 3**



**FIGURE 4**

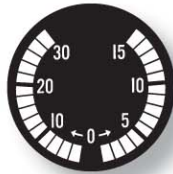

**FIGURE 5**



**FIGURE 6**



**FIGURE 7**

Kit #	Figure	Family	Dial Graphics	Characteristic
<b>0-30 HG MECHANICAL VACUUM GAUGE</b> <span style="float: right;"><b>2 1/16"</b></span>				
284AH	1	HD	VACUUM in. Hg.	
82117	1	DLX	VACUUM in. Hg.	Marine Deluxe
82328	1	DLX	VACUUM in. Hg.	
82383	1	HD+	VACUUM in. Hg. ☼	
82718	7	WW	VACUUM in. Hg/mm Hg ☼	Dual Scale/English Dominant
82745	2	HD+	VACUUM in. Hg/mm Hg ☼	Dual Scale/English Dominant
82861-P	1	TF	VACUUM	Black Bezel
82881-P	1	TF	VACUUM	Stainless Steel Bezel

Kit #	Figure	Family	Dial Graphics	Characteristic
<b>0-30 HG MECHANICAL VACUUM GAUGE</b> <span style="float: right;"><b>2 5/8"</b></span>				
82411	1	DLX	VACUUM INCHES	
82811-P	1	TF	VACUUM	Black Bezel
82831-P	1	TF	VACUUM	Stainless Steel Bezel

Kit #	Figure	Family	Dial Graphics	Characteristic
<b>0-30 HG VACUUM FUEL ECONOMY GAUGE</b> <span style="float: right;"><b>2 1/16"</b></span>				
82301	3	HD	FUEL EFFICIENCY Motor Minder	Includes T-fitting and hose
82460	3	HD	FUEL EFFICIENCY Motor Minder	Pedestal Mount

Kit #	Figure	Family	Dial Graphics	Characteristic
<b>0-30 HG/0-15 PSI MECHANICAL TURBO BOOST</b> <span style="float: right;"><b>2 1/16"</b></span>				
284BF	5	HD	Turbo in. Hg. PSI	Red Pointer
82340	5	DLX	Turbo in. Hg. PSI	Red Pointer
82864-P	4	TF	PSI-in. Hg.	Black Bezel
82884-P	4	TF	PSI-in. Hg.	Stainless Steel Bezel

Kit #	Figure	Family	Dial Graphics	Characteristic
<b>0-30 HG/0-40 PSI MECHANICAL TURBO BOOST</b> <span style="float: right;"><b>2 1/16"</b></span>				
82491	6	WINGS	BOOST	White Facial
82492	6	WINGS	BOOST	Black Facial

Kit #	Figure	Family	Dial Graphics	Characteristic
<b>0-30 HG/0-40 PSI MECHANICAL TURBO BOOST</b> <span style="float: right;"><b>2 5/8"</b></span>				
82814-P	6	TF	PSI-in. Hg.	Black Bezel
82834-P	6	TF	PSI-in. Hg.	Stainless Steel Bezel

## AIR RESTRICTION



**FIGURE 1**

Kit #	Figure	Family	Dial Graphics	Characteristic
<b>5-40 AIR RESTRICTION GAUGE</b> <span style="float: right;"><b>2 1/16"</b></span>				
82384	1	HD+	AIR in H <sub>2</sub> O vac ☼	

Vacuum Tube Kits See Page 37

# 10 MECHANICAL SPEEDOMETERS

STEWART WARNER BRAND PRODUCTS



**DELUXE (DLX)**



**HEAVY DUTY (HD)**



**HEAVY DUTY PLUS (HD+)**



**WINGS**



**FIGURE 1**



**FIGURE 1**



**FIGURE 2**



**FIGURE 1**



**FIGURE 2**



**FIGURE 1**



**FIGURE 2**



**FIGURE 3**



**FIGURE 4**



**FIGURE 1**



**FIGURE 2**

Kit #	Figure	Family	Dial Graphics	Characteristic
<b>0-10 MPH MECHANICAL SPEEDOMETER</b> <span style="float: right;"><b>3 3/8"</b></span>				
550KM	1	DLX	MPH 1/10 1/100	Odometer/2.95 Diameter
<b>10-60 MPH BOAT SPEEDOMETER (PITOT TUBE 83066)</b> <span style="float: right;"><b>3 3/8"</b></span>				
82153	1	DLX	MPH	Marine Deluxe
83060	1	SWTHY	MPH	White Bezel/White Facial
83061	1	SWTHY	MPH	Red Bezel/White Facial
83062	1	SWTHY	MPH	Purple Bezel/White Facial
83063	1	SWTHY	MPH	Blue Bezel/White Facial
83064	1	SWTHY	MPH	Gray Bezel/White Facial
83065	1	SWTHY	MPH	Teal Bezel/White Facial
<b>20-75 MPH BOAT SPEEDOMETER (PITOT TUBE 83066)</b> <span style="float: right;"><b>3 3/8"</b></span>				
82152	2	DLX	MPH	Marine Deluxe
<b>0-80 MPH MECHANICAL SPEEDOMETER</b> <span style="float: right;"><b>3 3/8"</b></span>				
550HF-D	2	HD	MPH HIGH BEAM	Odometer/High Beam Indicator
82665	2	WINGS	MILES PER HOUR	Odometer/White Facial
82666	2	WINGS	MILES PER HOUR	Odometer/Black Facial
82680	1	WW	km/hr. MILES MPH	Odometer/Dual Scale/English Dominant
82692	1	DLX	km/h MPH	Odometer/Dual Scale/English Dominant
<b>5-85 MPH/0-130 km/h MECHANICAL SPEEDOMETER</b> <span style="float: right;"><b>3 3/8"</b></span>				
82677	1	DLX	km/h MPH	Odometer/Dual Scale/English Dominant
82678	1	HD	km/h MPH	Odometer/Dual Scale/English Dominant
82694	1	HD+	km/h MPH	Odometer/Dual Scale/English Dominant
<b>0-140 km/h/5-85 MPH MECHANICAL SPEEDOMETER</b> <span style="float: right;"><b>3 3/8"</b></span>				
82695	2	HD+	MPH km/h	Metric Odometer/Dual Scale/ Metric Dominant
<b>0-140 km/h MECHANICAL SPEEDOMETER</b> <span style="float: right;"><b>3 3/8"</b></span>				
82697	3	DLX	km/h	Metric Odometer/Metric Deluxe
<b>0-140 km/h/0-90 MPH MECHANICAL SPEEDOMETER</b> <span style="float: right;"><b>3 3/8"</b></span>				
82676	4	WW	km/h MPH	Metric Odometer/Dual Scale/ Metric Dominant
<b>0-160 MPH MECHANICAL SPEEDOMETER</b> <span style="float: right;"><b>3 3/8"</b></span>				
550BP-D	1	DLX	MPH	Odometer
550HH-D	1	HD	MPH	Odometer
82663	1	WINGS	MILES PER HOUR	Odometer/White Facial
82664	1	WINGS	MILES PER HOUR	Odometer/Black Facial
82852-P	1	TF	MPH	Odometer/Black Bezel
82872-P	1	TF	MPH	Odometer/Stainless Steel Bezel
<b>0-180 MPH MECHANICAL SPEEDOMETER</b> <span style="float: right;"><b>3 3/8"</b></span>				
550ABE	2	DLX	MPH	Odometer/Counter Clockwise Reading/ Use 411335-D counter clockwise adapter





HEAVY DUTY (HD)



TRACK FORCE (TF)



HEAVY DUTY PLUS (HD+)



DELUXE (DLX)



FIGURE 1



FIGURE 1



FIGURE 2



FIGURE 1



FIGURE 2



FIGURE 3

Kit #	Figure	Family	Dial Graphics	Characteristic
<b>0-3000 RPM TACHOMETER</b> <span style="float: right;"><b>3 3/8"</b></span>				
82696	1	HD+	ENGINE REVS. X 100000 RPM x100	.5:1 Ratio/Hourmeter
<b>0-3500 RPM TACHOMETER</b> <span style="float: right;"><b>3 3/8"</b></span>				
82688	1	DLX	ENGINE HOURS RPM x100	.5:1 Ratio/Hourmeter
82689	1	DLX	RPM x100	.5:1 Ratio
82690	1	DLX	ENGINE HOURS RPM x100	1:1 Ratio/Hourmeter
82691	1	DLX	RPM x100	1:1 Ratio
551AHK-D	2	HD	RPM x100	.5:1 Ratio
551AHL-D	2	HD	RPM x100 ENGINE REVS. X 100000	.5:1 Ratio/Hourmeter
<b>0-5000 RPM TACHOMETER</b> <span style="float: right;"><b>3 3/8"</b></span>				
551AKM-D	1	DLX	RPM HUNDREDS	.5:1 Ratio
<b>0-9000 RPM TACHOMETER</b> <span style="float: right;"><b>3 3/8"</b></span>				
535AK-D	2	HD	RPM x1000	.5:1 Ratio
535AH-D	2	DLX	RPM x1000	.5:1 Ratio
<b>0-10000 RPM TACHOMETER</b> <span style="float: right;"><b>3 3/8"</b></span>				
82851-P	3	TF	RPM x1000	.5:1 Ratio/Adj Redline/Black Bezel
82871-P	3	TF	RPM x1000	.5:1 Ratio/Adj Redline/Stainless Steel Bezel
<b>0-10000 RPM TACHOMETER</b> <span style="float: right;"><b>5"</b></span>				
82801-P	3	TF	RPM x1000	.5:1 Ratio/Adj Redline/Black Bezel
82821-P	3	TF	RPM x1000	.5:1 Ratio/Adj Redline/Stainless Steel Bezel



DELUXE (DLX)



HEAVY DUTY (HD)



HEAVY DUTY PLUS (HD+)



WINGS



FIGURE 1

Kit #	Figure	Family	Dial Graphics	Characteristic
<b>0-3500 RPM DIESEL TACH (SENDER 82623B) HALL EFFECT 3 3/8"</b>				
82620	1	DLX	RPM x100	Selectable Ratio .5, 1, 1.5, 2
82622	1	DLX	RPM x100 HOURS 1/10	Selectable Ratio .5, 1, 1.5, 2/Hourmeter
82619	1	HD	RPM x100	Selectable Ratio .5, 1, 1.5, 2
82633	1	WW	RPM x100	Selectable Ratio .5, 1, 1.5, 2
82635	1	DLX	r/min x 100	Selectable Ratio .5, 1, 1.5, 2/ Alternator Application
82640	1	HD	RPM x100	Selectable Ratio .5, 1, 1.5, 2/ Alternator Application
82643	1	HD+	RPM x100	Selectable Ratio .5, 1, 1.5, 2/ Alternator Application
82647	1	HD+	RPM x100 HOURS 1/10	Selectable Ratio .5, 1, 1.5, 2/Hourmeter
82671	1	WINGS	RPM HUNDREDS	Selectable Ratio .5, 1, 1.5, 2/ Alternator Application/White Facial
82672	1	WINGS	RPM HUNDREDS	Selectable Ratio .5, 1, 1.5, 2/ Alternator Application/Black Facial
<b>0-3500 RPM DIESEL TACH (SENDER 82646) MAG. PICKUP 3 3/8"</b>				
82636	1	DLX	r/min x 100	Selectable Ratio .5, 1, 1.5, 2/ Flywheel Application
82641	1	HD	RPM x100	Selectable Ratio .5, 1, 1.5, 2/ Flywheel Application
82644	1	HD+	RPM x100	Selectable Ratio .5, 1, 1.5, 2/ Flywheel Application
82673	1	WINGS	RPM HUNDREDS	Selectable Ratio .5, 1, 1.5, 2/ Flywheel Application/White Facial
82674	1	WINGS	RPM HUNDREDS	Selectable Ratio .5, 1, 1.5, 2/ Flywheel Application/Black Facial
<b>0-3500 RPM DIESEL TACH (ALTERNATOR APPLICATION) 3 3/8"</b>				
82635	1	DLX	r/min x 100	Selectable Ratio .5, 1, 1.5, 2/ Alternator Application
82640	1	HD	RPM x100	Selectable Ratio .5, 1, 1.5, 2/ Alternator Application
82643	1	HD+	RPM x100	Selectable Ratio .5, 1, 1.5, 2/ Alternator Application
82671	1	WINGS	RPM HUNDREDS	Selectable Ratio .5, 1, 1.5, 2/ Alternator Application/White Facial
82672	1	WINGS	RPM HUNDREDS	Selectable Ratio .5, 1, 1.5, 2/ Alternator Application/Black Facial
82621	1	HD	RPM x100	Alternator Application / Hourmeter
<b>0-3500 RPM DIESEL 24V TACHOMETER (SENDER 82623B) 3 3/8"</b>				
82651	1	HD	RPM x100 HOURS 1/10	24v/Hourmeter/Alternator Application
<b>0-3500 RPM DIESEL TACHOMETER (SENDER 82623B) 5"</b>				
82601	1	HD	RPM x100	Programmable/Alternator Application

When power to an electrical gauge is turned off, pointer may come to rest at any point on the dial.

Senders See Page 39  
See Page 49 for Wiring Information





HEAVY DUTY PLUS (HD+)



TRACK FORCE (TF)



SEAWORTHY (SWTHY)



DELUXE (DLX)



FIGURE 1



FIGURE 2

Kit #	Figure	Family	Dial Graphics	Characteristic
<b>0-6000 RPM GAS/IGNITION TACHOMETER</b> <span style="float: right;"><b>3 3/8"</b></span>				
82162B*	1	DLX	RPM x1000	4, 6, and 8 Cylinder
82164B*	1	HD	RPM x1000	4, 6, and 8 Cylinder
82648	1	HD+	RPM x1000	4, 6, and 8 Cylinder
83036	1	SWTHY	RPM x1000	4, 6, and 8 Cylinder/White Bezel/ White Facedral
83037	1	SWTHY	RPM x1000	4, 6, and 8 Cylinder/Red Bezel/ White Facedral
83038	1	SWTHY	RPM x1000	4, 6, and 8 Cylinder/Purple Bezel/ White Facedral
83039	1	SWTHY	RPM x1000	4, 6, and 8 Cylinder/Blue Bezel/ White Facedral
83040	1	SWTHY	RPM x1000	4, 6, and 8 Cylinder/Gray Bezel/ White Facedral
83041	1	SWTHY	RPM x1000	4, 6, and 8 Cylinder/Teal Bezel/ White Facedral
<b>0-6000 RPM GAS/IGNITION TACHOMETER</b> <span style="float: right;"><b>2 1/16"</b></span>				
82650	2	HD+	RPM x100	4 Cylinder Only
<b>0-8000 RPM GAS/IGNITION TACHOMETER</b> <span style="float: right;"><b>3 3/8"</b></span>				
82163	1	DLX	RPM x1000	4, 8, and 12 Cylinder
82659	1	WINGS	RPM HUNDREDS	4, 6, and 8 Cylinder/White Facedral
82660	1	WINGS	RPM HUNDREDS	4, 6, and 8 Cylinder/Black Facedral
82165	1	HD	RPM x1000	4, 8, and 12 Cylinder
82170	1	DLX	RPM x1000	4, 6, and 8 Cylinder
82171	1	HD	RPM x1000	4, 6, and 8 Cylinder
82171B*	1	HD	RPM x1000	4, 6, and 8 Cylinder
82649	1	HD+	RPM x1000	4, 6, and 8 Cylinder
82608	1	WINGS	RPM HUNDREDS	4, 6, and 8 Cylinder / Gold
<b>0-10000 RPM GAS/IGNITION TACHOMETER</b> <span style="float: right;"><b>3 3/8"</b></span>				
82850-P	1	TF	RPM x1000	4, 6, and 8 Cylinder/Adj Redline/ Black Bezel
82873-P	1	TF	RPM x1000	4, 6, and 8 Cylinder/Adj Redline/ Stainless Steel Bezel
<b>0-10000 RPM GAS/IGNITION TACHOMETER</b> <span style="float: right;"><b>5"</b></span>				
82800-P	1	TF	RPM x1000	4, 6, and 8 Cylinder/Telltale Memory/ Black Bezel
82803-P	1	TF	RPM x1000	4, 6, and 8 Cylinder/Black Bezel
82820-P	1	TF	RPM x1000	4, 6, and 8 Cylinder/Telltale Memory/Stainless Steel Bezel
82823-P	1	TF	RPM x1000	4, 6, and 8 Cylinder/Stainless Steel Bezel
<b>0-12000 RPM GAS/IGNITION TACHOMETER</b> <span style="float: right;"><b>5"</b></span>				
82802-P	1	TF	RPM x1000	4, 6, and 8 Cylinder/Telltale Memory/ Black Bezel
82822-P	1	TF	RPM x1000	4, 6, and 8 Cylinder/Telltale Memory/ Stainless Steel Bezel

\*Improved Signal Filtering

See Page 49 for Wiring Information



FIGURE 1

# 14 ELECTRIC SPEEDOMETERS / PYROMETERS

STEWART WARNER BRAND PRODUCTS



**DELUXE (DLX)**



**HEAVY DUTY (HD)**



**HEAVY DUTY PLUS (HD+)**



**WINGS**



**FIGURE 1**



**FIGURE 1**



**FIGURE 2**



**FIGURE 3**



**FIGURE 1**



**FIGURE 1**

**0-30 MPH ELECTRIC SPEEDOMETER (SENDER 82623B) 3 3/8"**

Kit #	Figure	Family	Dial Graphics	Characteristic
82603	1	HD+	km/h MPH MILES	Programmable/Odometer/Dual Scale/English Dominant

**5-85 MPH ELECTRIC SPEEDOMETER (SENDER 82623B/82646) 3 3/8"**

82604	2	HD	MPH	Programmable for Transmission Control on Electronic Engines/Odometer/Square Wave
82637	1	DLX	km/h mph	Programmable/Odometer/Dual Scale/English Dominant
82645	1	HD+	km/h MPH MILES	Programmable/Odometer/Dual Scale/English Dominant
82642	2	HD	MPH	Programmable/Odometer
82656	3	DLX	MPH km/h km	Metric Deluxe/Programmable/Metric Odometer/Dual Scale/Metric Dominant
82658	3	HD+	MPH km/h km	Programmable/Metric Odometer/Dual Scale/Metric Dominant

**0-85 MPH ELECTRIC SPEEDOMETER (SENDER 82623B/82646) 5"**

82600	2	HD	MPH	Programmable/Odometer
-------	---	----	-----	-----------------------

**0-120 MPH ELECTRIC SPEEDOMETER (SENDER 82527/82646) 3 3/8"**

82669	1	WINGS	MILES PER HOUR	Programmable/Odometer/White Facial
82670	1	WINGS	MILES PER HOUR	Programmable/Odometer/Black Facial
82896	1	DLX	MPH	Programmable/Odometer

**0-160 MPH ELECTRIC SPEEDOMETER (SENDER 82623B/82646) 3 3/8"**

82661	1	WINGS	MILES PER HOUR	Programmable/Odometer/White Facial
82662	1	WINGS	MILES PER HOUR	Programmable/Odometer/Black Facial

**0-160 MPH ELECTRIC SPEEDOMETER (SENDER 82623B/82646) 5"**

82698	1	DLX	MPH	Programmable/Odometer
82898	1	DLX	MPH	Programmable/Odometer/White Facial

Senders See Page 39  
See Page 49 for Wiring Information

**PYROMETER**



**FIGURE 1**



**FIGURE 2**



**82505**



**FIGURE 3**

**300-1500°F PYROMETER (SENDER 82505) 2 1/16"**

Kit #	Figure	Family	Dial Graphics	Characteristic
82334	1	HD	°F x100 TEMP	
82335	1	DLX	°F x100 TEMPERATURE	
82357	2	HD+	°F EXHAUST	
82485	1	WINGS	°F x100 PYROMETER	White Facial
82486	1	WINGS	°F x100 PYROMETER	Black Facial

**SENDER 82505 (THERMOCOUPLE 17" LONG)**

82556-1	3			5 Foot Extension
82556-2	3			10 Foot Extension
82556-3	3			20 Foot Extension

Order pyrometer, sender and extensions separately.





WORLD WIDE (WW)



HEAVY DUTY (HD)



HEAVY DUTY PLUS (HD+)



DELUXE (DLX)

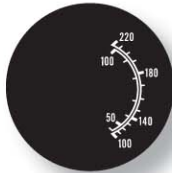

FIGURE 1



FIGURE 2



FIGURE 3



FIGURE 4



FIGURE 5



FIGURE 6



FIGURE 7



FIGURE 8



FIGURE 9



FIGURE 10



FIGURE 11



FIGURE 12



FIGURE 13



FIGURE 14

When power to an electrical gauge is turned off, pointer may come to rest at any point on the dial.

Kit #	Figure	Family	Dial Graphics	Characteristic
<b>100-220°F OIL TEMPERATURE (SENDER 280EC)</b> <span style="float:right">2 1/16"</span>				
82708	1	WW	HYDRAULIC OIL TEMP °C °F	
<b>100-230°F WATER TEMPERATURE (SENDER 280EC)</b> <span style="float:right">2 1/16"</span>				
284AF	2	HD	WATER °F	
<b>100-240°F WATER TEMPERATURE (SENDER 280EA)</b> <span style="float:right">2 1/16"</span>				
82114	3	DLX	WATER TEMPERATURE	Marine Deluxe
82306	3	DLX	WATER TEMPERATURE	
82345	3	DLX	HYD. OIL TEMPERATURE	
<b>100-240°F WATER TEMPERATURE (SENDER 280EC)</b> <span style="float:right">2 1/16"</span>				
82374	3	HD+	°F WATER	
82389	4	DLX	°C	Metric Deluxe
82477	3	WINGS	WATER TEMP	White Facial
82478	3	WINGS	WATER TEMP	Black Facial
82730	5	HD+	°F °C COOLANT	Dual Scale/English Dominant
82740	5	HD+	°F °C HYD.	Dual Scale/English Dominant
<b>100-260°F WATER TEMPERATURE (SENDER 280ED-F)</b> <span style="float:right">2 1/16"</span>				
82355	6	HD+	COOLANT °F	
<b>100-280°F WATER TEMPERATURE (SENDER 280ED-F)</b> <span style="float:right">2 1/16"</span>				
284J	7	HD	WATER °F	
82115	7	DLX	OIL TEMPERATURE	Marine Deluxe
82307	7	DLX	WATER TEMPERATURE	
82702	8	WW	°C °F WATER TEMP	Dual Scale/English Dominant
82866-P	7	TF	WATER TEMP	Black Bezel
82886-P	7	TF	WATER TEMP	Stainless Steel Bezel
<b>100-280°F WATER TEMPERATURE (SENDER 280EA)</b> <span style="float:right">2 1/16"</span>				
82351	7	DLX	WATER TEMPERATURE	Positive Ground
<b>140-320°F OIL TEMPERATURE (SENDER 280EE-F)</b> <span style="float:right">2 1/16"</span>				
82308	9	DLX	OIL TEMPERATURE	
82352	9	DLX	OIL TEMPERATURE	Positive Ground
82375	9	HD+	TRANS °F	
82489	9	WINGS	OIL TEMP	White Facial
82490	9	WINGS	OIL TEMP	Black Facial
82739	11	HD+	°F °C TRANS	Dual Scale/English Dominant
82390	10	DLX	°C	Metric Deluxe
284K	9	HD	OIL TEMPERATURE	
<b>150-350°F OIL TEMPERATURE (SENDER 280EE-F)</b> <span style="float:right">2 1/16"</span>				
82344	13	DLX	TRANS OIL TEMPERATURE	
82706	14	WW	ENGINE OIL TEMP °C °F	Dual Scale/English Dominant
82715	14	WW	CONV OIL TEMP	
82731	12	HD+	°F °C OIL	Dual Scale/English Dominant
82732	12	HD+	°F °C CONV.	Dual Scale/English Dominant

Temperature Senders See Page 24



DELUXE (DLX)



HEAVY DUTY (HD)



HEAVY DUTY PLUS (HD+)



SEAWORTHY (SWTHY)



FIGURE 1



FIGURE 1



FIGURE 1



FIGURE 2



FIGURE 3

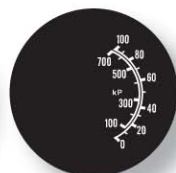

FIGURE 4

Kit #	Figure	Family	Dial Graphics	Characteristic
<b>0-16 PSI FUEL PRESSURE (82504-F SENDER) 2 1/16"</b>				
82333	1	DLX	FUEL PRESSURE	
284AM	1	HD	FUEL PSI	
82868-P	1	TF	FUEL PSI	Black Bezel
82888-P	1	TF	FUEL PSI	Stainless Steel Bezel
83067	1	SWTHY	FUEL PSI	White Bezel/White Facial
83068	1	SWTHY	FUEL PSI	Red Bezel/White Facial
83069	1	SWTHY	FUEL PSI	Purple Bezel/White Facial
83070	1	SWTHY	FUEL PSI	Blue Bezel/White Facial
83071	1	SWTHY	FUEL PSI	Gray Bezel/White Facial
83072	1	SWTHY	FUEL PSI	Teal Bezel/White Facial
<b>0-80 PSI OIL PRESSURE (279A OR 82892 SENDER) 2 1/16"</b>				
82304	1	DLX	OIL PRESSURE	
82113	1	DLX	OIL PRESSURE	Marine Deluxe
82354	1	HD+	OIL psi	
284AE	1	HD	OIL PSI	
83018	1	SWTHY	OIL PSI	White Bezel/White Facial
83019	1	SWTHY	OIL PSI	Red Bezel/White Facial
83020	1	SWTHY	OIL PSI	Purple Bezel/White Facial
83021	1	SWTHY	OIL PSI	Blue Bezel/White Facial
83022	1	SWTHY	OIL PSI	Gray Bezel/White Facial
83023	1	SWTHY	OIL PSI	Teal Bezel/White Facial
82473	1	WINGS	OIL PRESS	White Facial
82474	1	WINGS	OIL PRESS	Black Facial
<b>0-100 PSI OIL &amp; FUEL PRESSURE (279B-F OR 82893* SENDER) 2 1/16"</b>				
82305	1	DLX	OIL PRESSURE	
82349	1	DLX	OIL PRESSURE	Positive Ground
82116*	1	DLX	OIL PRESSURE	Marine Deluxe
82358	1	HD+	OIL psi	
82728	2	HD+	OIL psi  kPa	Dual Scale/English Dominant
82387	3	DLX	kPa	Metric Deluxe
284L	1	HD	OIL PSI	
82705	4	WW	ENGINE OIL PRESS psi kPa	Dual Scale/English Dominant
82865-P	1	TF	OIL PRESS	Black Bezel
82885-P	1	TF	OIL PRESS	Stainless Steel Bezel
83042*	1	SWTHY	FUEL PSI	White Bezel/White Facial
83043*	1	SWTHY	FUEL PSI	Red Bezel/White Facial
83044*	1	SWTHY	FUEL PSI	Purple Bezel/White Facial
83045*	1	SWTHY	FUEL PSI	Blue Bezel/White Facial
83046*	1	SWTHY	FUEL PSI	Grey Bezel/White Facial
83047*	1	SWTHY	FUEL PSI	Teal Bezel/White Facial
82714	4	WW	CONVERTER OIL PRESS psi kPa	Dual Scale/English Dominant

\*Use 82893 Sender with 100 psi Fuel Pressure Gauges for Marine Applications

Pressure Senders See Page 23





DELUXE (DLX)



WORLD WIDE (WW)



TRACK FORCE (TF)



WINGS



FIGURE 1



FIGURE 2



FIGURE 3



FIGURE 1

Kit #	Figure	Family	Dial Graphics	Characteristic
<b>0-150 PSI AIR &amp; OIL PRESSURE (279C OR 82894 SENDER) 2 1/16"</b>				
82346	1	DLX	AIR PRESSURE	
284T	1	HD	AIR PSI	
82388	2	DLX	kPa	Metric Deluxe
82397	3	HD+	psi kPa OIL	Dual Scale/English Dominant
82906	1	HD+	Front Air Press psi	LED Warning Light Set 62 psi
82907	1	HD+	Rear Air Press psi	LED Warning Light Set 62 psi
Pressure Senders See Page 23				
<b>0-400 PSI DRIVE OIL PRESSURE (360406 VDO SENDER) 2 1/16"</b>				
82136	1	DLX	DRIVE OIL PRESSURE psi kPa	Marine Deluxe/Dual Scale/English Dominant

**VOLTMETER**



FIGURE 1



FIGURE 2



FIGURE 3

Kit #	Figure	Family	Dial Graphics	Characteristic
<b>10-16V VOLTMETER 2 1/16"</b>				
284H	2	HD	VOLTS	
82112	2	DLX	VOLTS	Marine Deluxe
82309	1	DLX	BATT CHG VOLTS	
82376	2	HD+	BATT. V	
82391	1	DLX	BATT. CHG V	
82481	2	WINGS	BATT CHG VOLTS	White Facedral
82482	2	WINGS	BATT CHG VOLTS	Black Facedral
82709	3	WW	BATT-ALT VOLTAGE volts	
82738	2	HD+	BATT. V	
82862-P	2	TF	VOLTS	Black Bezel
82882-P	2	TF	VOLTS	Stainless Steel Bezel
83012	2	SWTHY	VOLTS	White Bezel/White Facedral
83013	2	SWTHY	VOLTS	Red Bezel/White Facedral
83014	2	SWTHY	VOLTS	Purple Bezel/White Facedral
83015	2	SWTHY	VOLTS	Blue Bezel/White Facedral
83016	2	SWTHY	VOLTS	Gray Bezel/White Facedral
83017	2	SWTHY	VOLTS	Teal Bezel/White Facedral
<b>10-16V VOLTMETER 2 5/8"</b>				
82812-P	2	TF	VOLTS	Black Bezel
82832-P	2	TF	VOLTS	Stainless Steel Bezel



FIGURE 1



FIGURE 2

Kit #	Figure	Family	Dial Graphics	Characteristic
<b>20-32V VOLTMETER 2 1/16"</b>				
284AJ	2	HD	VOLTS	
82377	2	HD+	BATT. V	
82347	1	DLX	BATT CHG VOLTS	

When power to an electrical gauge is turned off, pointer may come to rest at any point on the dial.



**STANDARD (STD)**



**TRACK FORCE (TF)**



**HEAVY DUTY PLUS (HD+)**



**WORLD WIDE (WW)**



**FIGURE 1**



**FIGURE 2**



**FIGURE 3**

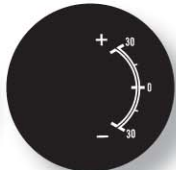

**FIGURE 4**



**FIGURE 5**



**FIGURE 6**

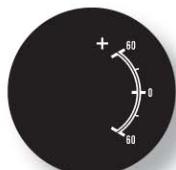

**FIGURE 7**



**FIGURE 8**



**FIGURE 9**



**FIGURE 10**



**FIGURE 11**

Kit #	Figure	Family	Dial Graphics	Characteristic
<b>20-0-20 AMMETER</b> <span style="float: right;"><b>2 1/32"</b></span>				
82201	1	STD	AMPERES	Internally Shunted/ Non-Illuminated Sealed Case
<b>30-0-30 AMMETER</b> <span style="float: right;"><b>2 1/16"</b></span>				
82200	3	STD	AMPERES	Internally Shunted/ Non-Illuminated Sealed Case/ 2 1/32" Case
82310	2	DLX	AMPERES	Internally Shunted
82713	4	WW	BATTERY amps	Internally Shunted
82736	2	HD+	BATTERY A	Internally Shunted
<b>60-0-60 AMMETER</b> <span style="float: right;"><b>2 1/16"</b></span>				
284A	5	HD	AMPERES	Internally Shunted
284AB	5	HD	AMPERES	Requires External Shunt #813489
82108	5	DLX	AMPS	Marine Deluxe/Internally Shunted
82109	5	DLX	AMPS	Marine Deluxe/Requires External Shunt #813489
82202	6	STD	AMPERES	Internally Shunted/Non-Illuminated Sealed Case/2 1/32" Case
82311	5	DLX	AMPERES	Internally Shunted
82359	5	HD+	BATTERY A	Requires External Shunt #813489
82700	7	WW	BATTERY amps	Internally Shunted
82737	5	HD+	BATTERY A	Requires External Shunt #813489
82855-P	5	TF	AMPS	Internally Shunted/Black Bezel
82875-P	5	TF	AMPS	Internally Shunted/Stainless Steel Bezel
<b>60-0-60 AMMETER</b> <span style="float: right;"><b>2 5/8"</b></span>				
82404	5	DLX	AMPERES	Internally Shunted
82805-P	5	TF	AMPS	Internally Shunted/Black Bezel
82825-P	5	TF	AMPS	Internally Shunted/Stainless Steel Bezel
<b>100-0-100 AMMETER</b> <span style="float: right;"><b>2 1/16"</b></span>				
284AA	8	HD	AMPERES	Requires External Shunt #407616
82110	8	DLX	AMPS	Marine Deluxe/ Requires External Shunt #407616
82313	8	DLX	AMPERES	Internally Shunted
82343	8	DLX	AMPERES	Requires External Shunt #407616
82360	8	HD+	BATTERY A	Requires External Shunt #407616
82701	9	WW	BATTERY amps	Internally Shunted
<b>150-0-150 AMMETER</b> <span style="float: right;"><b>2 1/16"</b></span>				
284AD	10	HD	AMPERES	Requires External Shunt #413717
82361	10	HD+	BATTERY A	Requires External Shunt #413717
<b>300-0-300 AMMETER</b> <span style="float: right;"><b>2 1/16"</b></span>				
82398	11	HD+	BATTERY A	Requires External Shunt #413717

Shunts See Page 39

Refer to instruction sheet for proper wire size and length for ammeters with external shunts.





DELUXE (DLX)



HEAVY DUTY (HD)



HEAVY DUTY PLUS (HD+)



SEAWORTHY (SWTHY)



FIGURE 1



FIGURE 2



FIGURE 3

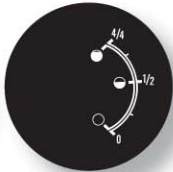

FIGURE 4



FIGURE 5

**240 OHM FUEL LEVEL GAUGE (SW) 2 1/16"**

Kit #	Figure	Family	Dial Graphics	Characteristic
284M	1	HD	FUEL	240 OHM
82905	1	HD+	FUEL	240 OHM/Low Level LED Lamp
82111	1	DLX	FUEL	240 OHM/Marine Deluxe
82211	2	STD	FUEL	240 OHM/2 1/32" Case
82303	1	DLX	FUEL	240 OHM
82353	1	DLX	FUEL	240 OHM/Positive Ground
82378	3	HD+	FUEL	240 OHM
82386	5	DLX		240 OHM
82471	1	WINGS	FUEL	240 OHM/White Facedral
82472	1	WINGS	FUEL	240 OHM/Black Facedral
82712	4	WW	TANK LEVEL	240 OHM
82733	3	HD+	FUEL	240 OHM
82863-P	3	TF	FUEL	240 OHM/Black Bezel
82883-P	3	TF	FUEL	240 OHM/Stainless Steel Bezel
83006	1	SWTHY	FUEL	240 OHM/White Bezel/White Facedral
83007	1	SWTHY	FUEL	240 OHM/Red Bezel/White Facedral
83008	1	SWTHY	FUEL	240 OHM/Purple Bezel/White Facedral
83009	1	SWTHY	FUEL	240 OHM/Blue Bezel/White Facedral
83010	1	SWTHY	FUEL	240 OHM/Gray Bezel/White Facedral
83011	1	SWTHY	FUEL	240 OHM/Teal Bezel/White Facedral

**90 OHM FUEL LEVEL GAUGE (GM) 2 1/16"**

284BS	1	HD	FUEL	90 OHM
82341	1	DLX	FUEL	90 OHM
82379	3	HD+	FUEL	90 OHM
82493	1	WINGS	FUEL	90 OHM/White Facedral
82494	1	WINGS	FUEL	90 OHM/Black Facedral
82734	3	HD+	FUEL	90 OHM
82869-P	3	TF	FUEL	90 OHM/Black Bezel
82889-P	3	TF	FUEL	90 OHM/Stainless Steel Bezel

**73 OHM FUEL LEVEL GAUGE (FORD/CHRYSLER) 2 1/16"**

284BR	1	HD	FUEL	73 OHM
82342	1	DLX	FUEL	73 OHM
82495	1	WINGS	FUEL	73 OHM/White Facedral
82496	1	WINGS	FUEL	73 OHM/Black Facedral
82735	1	HD+	FUEL	73 OHM
82870-P	3	TF	FUEL	73 OHM/Black Bezel
82890-P	3	TF	FUEL	73 OHM/Stainless Steel Bezel

**240 OHM FUEL LEVEL GAUGE (SW) 2 5/8"**

82413	1	DLX	FUEL	240 OHM
82813-P	3	TF	FUEL	240 OHM/Black Bezel
82833-P	3	TF	FUEL	240 OHM/Stainless Steel Bezel

Fuel Senders See Page 22

**BOW TRIM**



FIGURE 1

**BOW TRIM 2 1/16"**

Kit #	Figure	Family	Dial Graphics	Characteristic
82124	1	DLX	BOW TRIM	Marine Deluxe
284BP	1	HD	BOW TRIM	
83054	1	SWTHY	BOW TRIM	White Bezel/White Facedral
83055	1	SWTHY	BOW TRIM	Red Bezel/White Facedral
83056	1	SWTHY	BOW TRIM	Purple Bezel/White Facedral
83057	1	SWTHY	BOW TRIM	Blue Bezel/White Facedral
83058	1	SWTHY	BOW TRIM	Gray Bezel/White Facedral
83059	1	SWTHY	BOW TRIM	Teal Bezel/White Facedral

When power to an electrical gauge is turned off, pointer may come to rest at any point on the dial.

Bow trim gauge to be used with original equipment manufacturer's sender.



24 VOLT



24 VOLT



24 VOLT



24 VOLT



FIGURE 1



FIGURE 2



FIGURE 3



FIGURE 4



FIGURE 5



FIGURE 6



FIGURE 7



FIGURE 8



FIGURE 9



FIGURE 10



FIGURE 11



FIGURE 12

**0-100 PSI ELECTRIC OIL PRESSURE (SENDER 279B-F) 2 1/16"**

Kit #	Figure	Family	Dial Graphics	Characteristic
84000	1	24 VOLT	psi kPa  OIL	Dual Scale/English Dominant
84001	2	24 VOLT	kPa psi	Dual Scale/Metric Dominant

Pressure Senders See Page 23

**100-240°F ELECTRIC COOLANT TEMP (SENDER 280EC) 2 1/16"**

84002	3	24 VOLT	°F °C  COOLANT	Dual Scale/English Dominant
84003	4	24 VOLT	°C °F	Dual Scale/Metric Dominant
84004	5	24 VOLT	°C °F  COOLANT	Dual Scale/Metric Dominant

Temperature Senders See Page 24

**100-300°F ELECTRIC TRANS TEMP (SENDER 280ED-F) 2 1/16"**

84005	6	24 VOLT	°F °C  TRANS	Dual Scale/English Dominant
84006	7	24 VOLT	°C °F	Dual Scale/Metric Dominant

Temperature Senders See Page 24

**ELECTRIC FUEL GAUGE (SW) 2 1/16"**

84007	8	24 VOLT	FUEL	240 ohm
-------	---	---------	------	---------

Fuel Senders See Page 22

**20-32 V VOLTMETER 2 1/16"**

84008	9	24 VOLT	BATTERY  V	
-------	---	---------	------------	--

**10-150 PSI MECHANICAL AIR PRESSURE GAUGE 2 1/16"**

84009	10	24 VOLT	kPa psi	Dual Scale/Metric Dominant
-------	----	---------	---------	----------------------------

Tubing Kits See Page 37

**0-140 KPH / 0-85 MPH SPEEDOMETER (SENDER 82623B) 3 3/8"**

82606	11	24 VOLT	MPH	Dual Scale/Metric Dominant Programmable for Transmission Control on Electronic Engines
-------	----	---------	-----	--

Speedometer Senders See Page 39

**0-3500 RPM TACH (SENDER 82623B) 3 3/8"**

82605	12	24 VOLT	MPH X 100	Diesel Tachometer/Alternator Application
-------	----	---------	-----------	--

Tachometer Senders See Page 39

When power to an electrical gauge is turned off, pointer may come to rest at any point on the dial.





83500

2 SCREW BLACK 10,000 HOURS

Operating Voltage	
10-80 VDC	83500

- Quartz Plus movement features reliable drive mechanism
- Compact design to fit any application
- Totally sealed case impervious to acids and solvents

Operating Voltage	
12-24 VDC	83506



83501

3 SCREW BLACK 10,000 HOURS

Operating Voltage	
10-80 VDC	83501

- Excellent vibration and shock resistance
- 3 screw hole flange for flexible mounting
- Quartz accuracy +/- .02%

Operating Voltage	
12-24 VDC	83508



83502

CHROME FLUSH CUP 10,000 HOURS

DLX GRAPHICS

Operating Voltage		
10-80 VDC	83502	2.27"
10-80 VDC	83505	2.50"

- Matches classic SW Deluxe black and white graphics
- Available in 2.27" and 2.50" diameters with chrome bezel
- Excellent vibration and shock resistance



83503

BLACK FLUSH CUP 10,000 HOURS

HD GRAPHICS

Operating Voltage		
10-80 VDC	83503	2.27"

- Matches traditional SW Heavy Duty styling
- Features raised black bezel with distinctive brushed bright rim
- Indicates operating time in hours and tenths, plus running indicator



83504

BLACK FLUSH CUP 10,000 HOURS

HD+ GRAPHICS

Operating Voltage		
10-80 VDC	83504	2.27"

- Green and white graphics to match the SW Heavy Duty Plus line
- Low profile attractive black bezel
- Quartz movement accuracy within +/- .02%

Operating Voltage	
12-24 VDC	83507

White Graphics Only

See Page 48 for Dimensions



**Materials and Finishes on External Parts**

**Flange:** steel, zinc dichromate finish

**Screw:** brass

**Lockwasher:** phosphor bronze

**Flat Washer:** brass

**Application Specification**

Fuel level sender plate and termination will withstand an internal pressure of 6 psi (41.4 kPa) when properly installed in the tank.

**THICK FILM FUEL SENDERS**

- Thick-film resistors deliver greater accuracy and will perform reliably for more than *twenty million cycles*.
- Phosphor bronze wiper with nickel silver contact provides *extended life under fuel sloshing, vibration and dither conditions*.
- Resistors are trimmed by computer-guided lasers to exact specifications for *greater accuracy*.
- Extended float arm support is impervious to side play from fuel sloshing in the tank.
- *Solid Lifecell™* float will not sink.
- Zinc dichromate finish and copper alloy hardware.

90 Ohm	
Float Position	Resistance Range
Full	88.0-92.0 ohms
Empty	0.0-2.0 ohms

240 Ohm	
Float Position	Resistance Range
Full	29.0-33.5 ohms
Empty	240-250 ohms

Thick Film Fuel Senders (Adjustable)			
Tank Depth	Stud Termination	Packard Connector**	Stud Termination
	Kit No.	Kit No.	Kit No.
4 1/2-24" depth, RH	240 ohm	240 ohm	90 ohm
6-12" depth, LH	385AB-P*	386AB-P*	
6-12" depth, RH	385B-F	386B-F	
10-15" depth, LH	385C-F	386C-F	
10-15" depth, RH	391A-F	392A-F	439361-F
15 1/2-24" depth, LH	391B-F	392B-F	439362-F
15 1/2-24" depth, RH	391C-D	392C-D	439363-D
27-36" depth, RH	391D-D	392D-D	439364-D
27-36" depth, RH	391PX-D		

Male Packard Connector Assembly - 82891  
 \*Spade terminal ground  
 \*\*Isolated Ground Sender

**Fuel Senders comply with NMMA requirements for fire resistance. Tested to USCG requirement #33 CFR 183.590.**

See Page 47 for Fuel Sender Dimensions

**THICK FILM FUEL SENDERS WITH PACKARD CONNECTORS**

- Available with sealed integrated Packard™ connectors. The connector assures a weather tight fit for a reliable electric connection and easy installation.
- Isolated ground enhances accuracy by eliminating possibility of measurement error caused by electrical ground loops.

**Note: Order Fuel Level Sender (Tank Unit) Installation Kit No. 366LP-F separately, if needed. Flange should be welded or soldered to tank. The kit contains: one flange, one 72030 rubber gasket, and five washers and screws.**



FUEL SENDER WITH LOW LEVEL SWITCH	
TANK DEPTH	
6-12" LH - 392RX-D	W / Packard Connector
6-12" RH - 392RX-D	W / Packard Connector
15 1/2-24" - 392RZ-D	W / Packard Connector
15 1/2-24" - 392SA-D	W / Packard Connector

Packard™ is a Trademark of Packard Electric



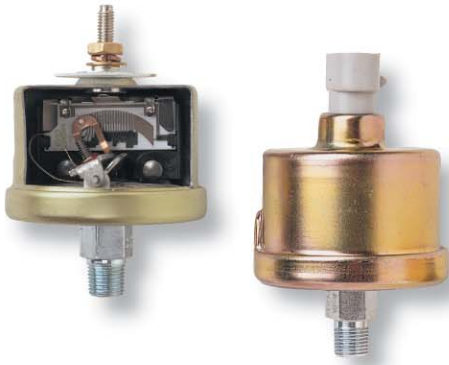

**Type:** diaphragm, thick film rheostat  
**Voltage:** 12 volts is normal operating voltage. Can be used in circuits up to 36 V with voltage adapter (see page 36)  
**Weight:** 5.5 ounces 56g

**Materials and Finishes**

**Cover:** steel, zinc dichromate finish  
**Flange and stud assembly:** steel, bright zinc  
**Terminal stud:** brass, white nickel  
**Hex nut:** brass  
**Lock washer:** phosphor bronze  
**Flat washer:** brass

**Application Specifications**

**Mounting position:** any orientation permissible  
**Ambient temperature range**  
**Operating:** -40°F through 300°F  
 -40°C through 149°C  
**Storage:** -40°F through 300°F  
 -40°C through 149°C

**THICK FILM PRESSURE SENDERS**

- Preferred for the most rigorous applications, thick film pressure senders will last up to **five times longer** than senders with wire-wound resistors.
- Trimmed by computer-guided lasers for **greater accuracy**.
- Kapton® high-temperature plastic diaphragms sealed with Viton® gaskets for **tighter seals and greater protection against oil leaks**.
- Available with sealed integrated Packard™ connectors. The connector assures a weather tight fit for a reliable electric connection and easy installation.

Thick Film Pressure Senders			
Stud Termination		Packard™ Connector	
Kit Number	Pressure	Kit Number	Resistance
279A	80 psi	82892	240 ohms
279B-F	100 psi	82893	240 ohms
279D	60 psi	82895	240 ohms
279C	150 psi	82894	240 ohms
82514*	80 psi		120 ohms
82501*	100 psi		120 ohms
82504-F	15 psi		240 ohms

Standard pipe thread is 1/8". Sales kits include adapter for 1/4" pipe thread.  
 \*Sender operates two gauges simultaneously, cannot be used with single gauge.

Pressure	Resistance (Nominal)	Limits
0 psi (0 Kps)	240 ohm	229. - 242.5
Full Rating	33.5 ohm	27.0 - 43.0

**Male Packard™ Connector Assembly - 82891**

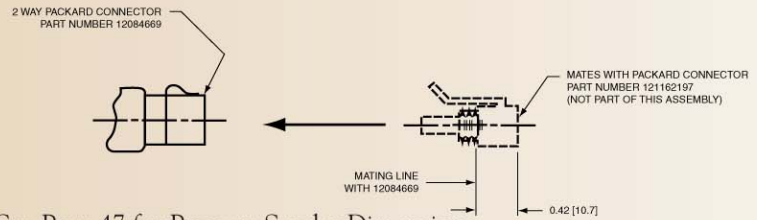

See Page 47 for Pressure Sender Dimensions

**FUEL SENDER ACCESSORIES**

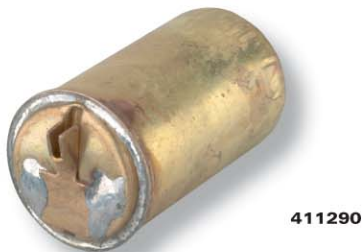

411290



836092



82891



72030

Accessories	Kit Number	Description
Brass Float	411290	With Clip
Brass Float	429354	With Shepard's Crook
Lifecell Float	836092	With Shepard's Crook
Replacement Gasket	72030	Neoprene Gasket
Male Packard Connector Assembly	82891	20" Leads
Peterbilt Harness Assembly	82897	22" Leads With Ring Terminals

TEMPERATURE SENDERS

- Constructed of high-quality, *corrosion-resistant brass* for maximum durability and outstanding electrical and thermal conductivity.
- Phosphor bronze contact spring provides *resistance to shock and vibration*.

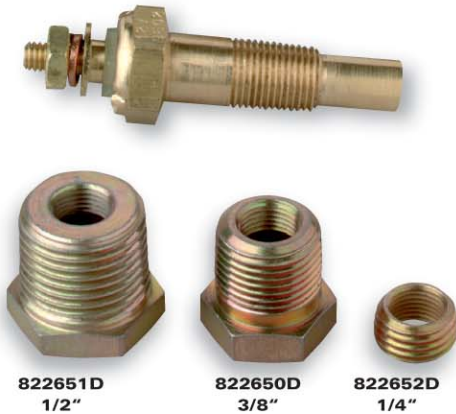

Temperature Senders				
Universal Sales Kit Number	Sales Kit Number	Thread Size	Hex Size	Temperature Range
280EC		1/8" NPTF	5/8"	100-230°F
	334N-D	1/4" NPTF	5/8"	100-230°F
	334K-D*	1/4" NPTF	5/8"	100-230°F
	334P-D	3/8" NPTF	3/4"	100-230°F
	334L-D*	3/8" NPTF	3/4"	100-230°F
280EA	334R-D	1/2" NPTF	7/8"	100-230°F
	334M-D*	1/2" NPTF	7/8"	100-230°F
	362CZ-D	1/8" NPTF	5/8"	100-240°F
82503*			5/8"	100-240°F
	362AN-D	1/4" NPTF	5/8"	100-240°F
	362BD-D*	1/4" NPTF	3/4"	100-240°F
	362AJ-D	3/8" NPTF	3/4"	100-240°F
	362BC-D*	3/8" NPTF	3/4"	100-240°F
	362AH-D	1/2" NPTF	7/8"	100-240°F
	362BB-D*	1/2" NPTF	7/8"	100-240°F
280ED-F	334H-D	1/8" NPTF	5/8"	100-280°F
	334AA-D	1/4" NPTF	5/8"	100-280°F
	334AB-D	3/8" NPTF	3/4"	100-280°F
280EE-F	334AD-D	1/2" NPTF	7/8"	100-280°F
		1/8" NPTF	5/8"	140-320°F
82505				300-1500°F

Standard pipe thread is 1/8". Universal sales kits include adapter for 1/4", 3/8" and 1/2" pipe thread.  
 \*Sender operates two gauges simultaneously, cannot be used with single gauge.

82510-F	Universal Metric-Adapters 14, 16, 18 mm Thread	100-280°F
---------	--	-----------

Gauge's specific sender should be checked on page 15.

See Page 47 for Temperature Sender Dimensions

TEMPERATURE SWITCHES

- *Solid brass* body.
- Gold-plated contacts.
- Excellent *accuracy* and repeatability.
- Normally open contact.
- Switches are voltage independent.



83300 Series Temperature Switches				
Sales Kit Number	Thread Size	Temperature	Terminal	Replaces
83300	1/4" NPTF	200°	Spade	363D-D
83301	1/4" NPTF	225°	Spade	363AM-D
83302	1/4" NPTF	225°	Screw	363BY
83303	1/4" NPTF	240°	Screw	363CP
83304	3/8" NPTF	200°	Spade	363E-D
83305	3/8" NPTF	220°	Screw	363AY
83306	3/8" NPTF	235°	Spade	363BR
83307	1/2" NPTF	200°	Spade	363F-D
83308	1/2" NPTF	200°	Screw	363P
83309	1/2" NPTF	215°	Screw	363AX
83310	1/2" NPTF	225°	Spade	363G-F
83311	1/2" NPTF	250°	Screw	363W-F
83312	1/2" NPTF	270°	Screw	363AB
83313	M16 x 1.5	225°	Spade	363CL
83314	M16 x 1.5	250°	Spade	363CM

See Page 47 for Temperature Switch Dimensions

PRESSURE SWITCHES



- Robust construction for *maximum strength*.
- Diaphragm assembly is normally closed.
- Switches are voltage independent.

1/8" PT

364L-F 6 psi

364K-F 15 psi

See Page 47 for Pressure Switch Dimensions





**Pressure and Vacuum Switch  
Standard Specifications**

**Type:** Direct action blade contact  
**Contacts:** Silver alloy, gold plated

**Pressure**

**Set Point:** Factory set from 0.5 to 150 PSI

**Operating Pressure:**

150 PSI for 0.5-24 PSI set point range  
250 PSI for 25-150 PSI set point range

**Proof Pressure:** 500 PSI

**Burst Pressure:**

750 PSI for 0.5-24 PSI set point range  
1250 PSI for 25-150 PSI set point range.

**Vacuum**

**Set Point:** Factory set

**Vacuum:** 1.1 to 22" Hg

**Operating Pressure:** 30" Hg vacuum max.

**Burst Pressure:** 150 PSI

**Ratings:**

**Resistive:** 15 AMP-6 VDC

8 AMP-12 VDC

4 AMP-24 VDC

**Inductive:** 1 AMP-120 VAC

0.5 AMP-240 VAC

**Pressure Diaphragm:** Polyimide film

**Vacuum Diaphragm:** Fluorosilicone

**Temperature Range:** -40° F to + 250° F

**Connector:** 1/8 -27 NPT male thread

**Terminals:** #8-32 screws

**Vacuum Circuitry:** -SPST-N.O., N.C.,

**Pressure Circuitry:** -SPST-N.O., N.C.,

1 circuit adjustable dual circuit, or  
2 circuits adjustable dual circuit. Also  
available are N.O./N.O. dual circuit  
and N.C./N.C. dual circuit.

**Base:** Brass

**Cover:** Glass reinforced polyester

**5000 SERIES PRESSURE AND VACUUM SWITCHES**

- 5000 Series switch specifically designed to stand up to extended duty applications.
- Outstanding design benefits are its durable construction, compact size, and enhanced set point integrity.
- Pressure switches feature Kapton diaphragms and the vacuum switches feature fluorosilicone rubber for compatibility with a wide variety of fluids.



79380

Pressure Switches / 5000 Series							
		Single Circuit 1 Terminal		Single Circuit 2 Terminal		Dual Circuit 3 Terminal	
Factory Set Point	Circuitry	Part Number	Compatible Part Number	Part Number	Compatible Part Number	Part Number	Compatible Part Number
1 psi	N.O.	78630		78628		78711	
	N.C.	78634		78632			
2 psi	N.O.	78142		76051		76071	
	N.C.	78149		76061			
4 psi	N.O.	78143	M4000	76575	M4006	76579	M4012
	N.C.	78150	M4001	76577	M4007		
10 psi	N.O.	78144		76576		76580	
	N.C.	78151		76578			
15 psi	N.O.	78145	M4002	76052	M4008	76072	M4013
	N.C.	78152	M4003	76062	M4009		
35 psi	N.O.	78146		76053		76073	
	N.C.	78153		76063			
60 psi	N.O.	78147	M4004	76054	M4010	76074	M4014
	N.C.	78154	M4005	76064	M4011		
100 psi	N.O.	78148	14731	76055	14732	76075	
	N.C.	78155	14729	76065	14728		

Vacuum Switches / 5000 Series							
		Single Circuit 1 Terminal		Single Circuit 2 Terminal		Dual Circuit	
Factory Set Point	Circuitry	Part Number	Compatible Part Number	Part Number	Compatible Part Number	Part Number	Compatible Part Number
4" Hg	N.O.			77342-4	M4076-4		
	N.C.			77343-4	M4077-4		
9" Hg	N.O.			77342-9	M4078-9		
	N.C.			77343-9	M4079-9		
17" Hg	N.O.			77342-17	M4080-17		
	N.C.			77343-17	M4081-17		
28 H2O	N.O.			77342-28		26503	
	N.C.			77343-28		26502	

Boot for 5000 Series: 79380

**Note: Operating Media (Pressure Switch)**

The pressure switch is designed to operate with air, motor oils, transmission oils, jet fuels and other similar hydrocarbon media.



<b>2 Screw Black</b>	
<b>Operating Voltage</b>	<b>2-Screw Black</b>
10-80 VDC	<b>85094-12</b>
30-110 VDC	<b>85013-12</b>
100,000 Hour 10-80 VDC	<b>85127-12</b>



<b>3 Screw Black</b>	
<b>Operating Voltage</b>	<b>3-Screw Black</b>
10-80 VDC	<b>85097-02</b>
30-110 VDC	<b>85014-02</b>
100,000 Hour 10-80 VDC	<b>85134-02</b>



<b>Rectangular Stirrup</b>	
<b>Operating Voltage</b>	<b>Rectangular Stirrup</b>
10-32 VDC	<b>85010-25</b>
30-110 VDC	<b>85023-25</b>



Operating Voltage	Chrome Flush Cup 2.27"	Chrome Flush Cup 2.50"	Chrome Stirrup 2.27"	Chrome Stirrup 2.50"	Black Flush 2.27"
10-32 VDC			85004-25	85008-25	
10-80 VDC	85342-03	85098-03			85093-03
30-110 VDC	85015-03	85019-03	85017-03	85021-03	
100,000 Hour 10-80 VDC	85135-03	85133-03			85126-03
100,000 Hour 10-32 VDC				85104-25	

85000 FEATURES AND SPECIFICATIONS

- Custom CMOS integrated circuit
- Indicates operating time in hours and tenths, plus has a running indicator
- 10,000 hour version standard, with automatic recycle to zero
- Totally-sealed
- Temperature range: -40° F to +185° F, 40° C to +85° C
- Quartz accuracy: ±200ppm, ±0.02% (entire voltage and temperature range)
- Operating voltage range: 5-110 VDC (Voltage range covered by 85000 Series line)
- Battery system voltages: 6,12,24,36,48,60,72,and 80 VDC
- Precision built relay driven odometer
- Excellent vibration & shock resistance:  
Vibration: 20g's @ 10-80Hz (SAE J1378) 10 g's (per MIL-M-3971)  
Shock: 55g's @ 9-13msec (SAE J1378) 75g's (per MIL-M-3971)
- Transient Voltage Protection Alternator load dump: 150V EMI (Electromagnetic Interference): +400V @ 500Hz Inductive switching and reverse polarity
- Standard terminals: 1/4" male blade
- Lens material: Glass
- Case material: Polyester
- Number size: 0.12" (3mm)
- UL Recognized (File number AU1774)
- CSA Certified (File number LR42455-12)
- Conforms to MIL-M-3971

85000 SERIES WIRING DIAGRAMS (POLARITY SENSITIVE)

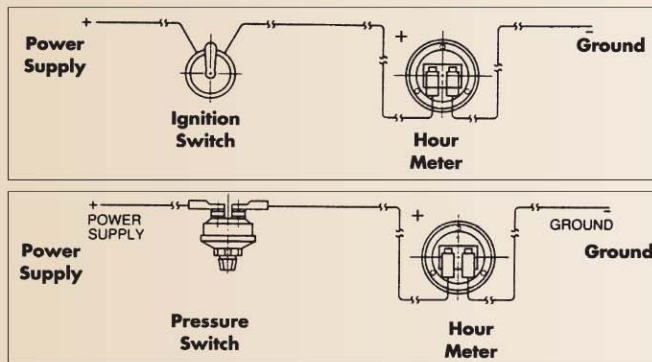

HOUR METER ACCESSORIES



**329-M** (2 13/16") mounting bracket for meter only.

**558-M** (4" x 5 1/8") meter and dampener together. DC only.



**3888-M** (3 7/8" dia.) dampener for three-screw type DC meters. Use on panel or with 558-M.



**486-M** Covers panel area 2 13/16" x 5 1/4". Three-screw type DC meter only.



**23944** angle bracket for all two-screw rectangular meters when panel mounting not practical.

See Page 48 for Dimensions





Rectangular 2 Screw			
Operating Voltage	Hertz	Termination	Part Number
22 to 26 VAC	60	Screw*	20085-17
108 to 132 VAC	50	Screw *	20028-17
108 to 132 VAC	50	7" Leads **	20034-17
108 to 132 VAC	60	Screw *	20001-17
108 to 132 VAC	60	7" Leads **	20035-17
216 to 264 VAC	50	Screw *	20029-17
216 to 264 VAC	50	7" Leads **	20036-17
216 to 264 VAC	60	Screw *	20007-17
216 to 264 VAC	61	7" Leads **	20037-17

\* UL Listed & CSA Certified  
\*\* UL Recognized & CSA Certified



Round 3 Screw			
Operating Voltage	Hertz	Termination	Part Number
108 to 132 VAC	50	Screw *	20016-14
108 to 132 VAC	50	7" Leads **	20042-14
108 to 132 VAC	60	Screw*	20017-14
216 to 264 VAC	50	Screw *	20018-14
216 to 264 VAC	60	Screw *	20019-14

\* UL Listed & CSA Certified  
\*\* UL Recognized & CSA Certified

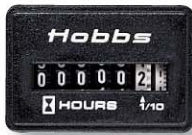

Rectangular Retainer Mount			
Operating Voltage	Hertz	Termination	Part Number
108-132 VAC	60	Screw *	20116-23

\* UL Listed and CSA Certified



Square Retainer Mount			
Operating Voltage	Hertz	Termination	Part Number
108-132 VAC	60	Screw *	20115-23

\* UL Listed and CSA Certified

20000 FEATURES AND SPECIFICATIONS

- Polycarbonate, shock resistant, tamper proof case
  - Records up to 99,999 hours Automatic recycle to zero
  - Totally sealed \*
  - Single phase, synchronous, permanently lubricated motor
  - 24,120 and 240 VAC models available (Range±10%)
  - 50 and 60 Hertz versions
  - 3.0 watts power rating
  - Operating temperature: -65°F to +154°F, (-54°C to +68°C)
  - Accuracy: ±.02%.
  - Weight: 3 oz
  - Screw termination or 7" lead wires
  - Lens material: 3-screw mount: Glass All others: Polycarbonate
  - Case material: Polycarbonate
  - Number size: 0.12" (3mm)
  - UL Listed (File# E47098): Screw terminals
  - UL Recognized: Wire lead versions
  - CSA Certified (File # LR42455)
  - Conforms to MIL-M-3971 \*
- \*Applicable on "Screw Terminal" Meters

20000 SERIES WIRING DIAGRAMS

120VAC Meter Applications

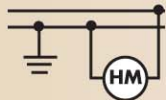

**Single phase, 2 wire, 120V system:** Connect power wire to one terminal and neutral wire to opposite terminal.

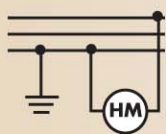

**Single phase, 3 wire, 120/240V system:** Connect any one power wire to one terminal and the neutral wire to the opposite terminal.

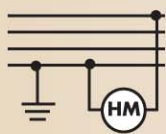

**Three phase, 4 wire, 120/208V system:** Connect any one power wire to one terminal and the neutral wire to the opposite terminal.

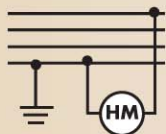

**Three phase, 4 wire delta with a high leg, 120/240V system:** Connect any one of the two available 120V power wires to one terminal of the meter and the neutral wire to the opposite terminal. Do not connect the high leg (208V) to the meter.

240VAC Meter Applications



**Single Phase, 2 wire, 240V system:** Connect power wire to one terminal and neutral wire to opposite terminal.

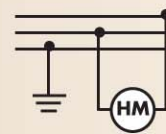

**Single phase, 3 wire, 120/240V system:** Connect meter across two high sides of the line. Do not connect the neutral wire to the meter.

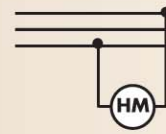

**Three phase, 3 wire delta, 240V system:** Connect any meter across any two power lines.

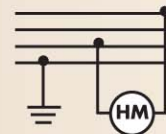

**Three phase, 4 wire delta with a high leg, 120/240V system:** Connect any one power wire to one terminal of the meter. Connect one of the remaining two power lines to the opposite terminal. Do not connect the neutral wire to the meter.

HOURLY METER ACCESSORIES



**329-M** (2 13/16") mounting bracket for meter only.



**23944** angle bracket for all two-screw rectangular meters when panel mounting not practical.

See Page 48 for Dimensions



4" x 6" Halogen



3" x 5" Halogen



5" Round Halogen

Complete Lamp Assembly			
Part No.	Beam Pattern	Voltage	Current
71898-11	Wide Flood	12V 50W	4 amp
74001-11	Narrow Flood	12V 50W	4 amp
71902-11	Spot	12V 50W	4 amp
71915-11	Trap	12V 50W	4 amp
75237-11	HI-LO Driving	12V 35/60W	3/5 amp
72540-11	Wide Flood	24V 60W	2.5 amp
75109-11	Narrow Flood	24V 60W	2.5 amp
72542-11	Trap	24V 60W	2.5 amp
72544-11	Spot	24V 60W	2.5 amp

Replacement Sealed Beams			
Part No.	Beam Pattern	Voltage	Current
71017-11	Wide Flood	12V 50W	4 amp
71791-11	Narrow Flood	12V 50W	4 amp
71792-11	Trap	12V 50W	4 amp
71794-11	Spot	12V 50W	4 amp
75251-11	HI-LO Driving	12V 35/60W	3/5 amp
72541-11	Wide Flood	24V 60W	2.5 amp
78856-11	Narrow Flood	24V 60W	2.5 amp
72543-11	Trap	24V 60W	2.5 amp
72545-11	Spot	24V 60W	2.5 amp

Marine Complete Lamp Assembly**				
Part No.	Mntg.	Beam Pattern	Voltage	Current
72656-23	Flush	80°x30° Flood	12V 50W	4 amp
72715-23	Flush	Spot	12V 50W	4 amp
71723-23	Stud	80°x30° Flood	12V 50W	4 amp
72716-23	Stud	Spot	12V 50W	4 amp
72666-23	Flush	80°x30° Flood	24V 60W	2.5 amp
72717-23	Flush	Spot	24V 60W	2.5 amp
72530-23	Stud	80°x30° Flood	24V 60W	2.5 amp
72718-23	Stud	Spot	24V 60W	2.5 amp

\*\*Marine Assembly-White Body

Marine Replacement Sealed Beams			
Part No.	Beam Pattern	Voltage	Current
72108-15	80°x30° Flood	12V 50W	4 amp
72719-15	Spot	12V 50W	4 amp
72728-15	80°x30° Flood	24V 60W	2.5 amp
72720-15	Spot	24V 60W	2.5 amp

Complete Lamp Assembly			
Part No.	Beam Pattern	Voltage	Current
73761-11	Wide Flood	12V 50W	4 amp
77861-49 <sup>1</sup>	Wide Flood	12V 50W	4 amp
73762-11	Narrow Flood	12V 50W	4 amp
73763-11	Trap	12V 50W	4 amp
73764-11	Spot	12V 50W	4 amp

<sup>1</sup> Lamp with built-in toggle switch

Replacement Sealed Beams			
Part No.	Beam Pattern	Voltage	Current
72408-11	Wide Flood	12V 50W	4 amp
72573-11	Narrow Flood	12V 50W	4 amp
72801-11	Trap	12V 50W	4 amp
73804-11	Spot	12V 50W	4 amp

Marine Complete Lamp Assembly**				
Part No.	Mntg.	Beam Pattern	Voltage	Current
73620-01	Flush	80°x30° Flood	12V 50W	4 amp

Includes Spreader Bracket

\*\*Marine Assembly-White Body

Marine Replacement Sealed Beams			
Part No.	Beam Pattern	Voltage	Current
74041-01	80°x30° Flood	12V 50W	4 amp

Complete Lamp Assembly			
Part No.	Beam Pattern	Voltage	Current
73468-11	Wide Flood	12V 50W	4 amp
73469-11	Trap	12V 50W	4 amp
73470-11	Spot	12V 50W	4 amp

Replacement Sealed Beams*			
Part No.	Beam Pattern	Voltage	Current
70510-11	Wide Flood	12V 50W	4 amp
70729-11	Trap	12V 50W	4 amp
72774-11	Spot	12V 50W	4 amp

\*will replace any 4-1/2" (par 36) incandescent or halogen sealed beam  
3322-M Grommet-5" Round

Mounting wire through stud except where noted

Dimensions				
	Height	Length	Width	Thread
4 X 6	4.49	6.90	3.78	1/2-13 NC-2
3 X 5	3.53	5.89	3.54	1/2-13 NC-2
5"	5.25 (Diameter)		3.72	1/2-20 N.F.

STANDARD BEAM PATTERN

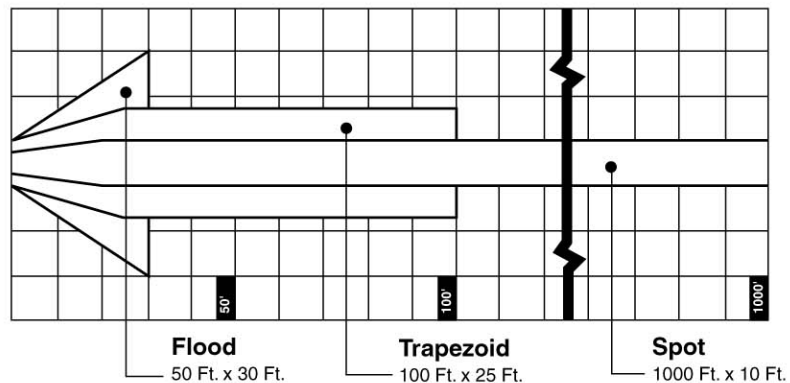

Text and data subject to technical modification.





80470

**PORTABLE WARNING LAMP**

- Heavy duty lamp features a two-way amber lens, magnetic base with 80 lbs. of pull-off force, and a built in flasher.
- Quickly affix this rugged lamp to any machinery or equipment you are transporting.
- S.A.E. approved warning lamp with integral flasher.
- Flash rate: 60-120 cycles per minute.
- 6 inch wire leads.

80470

Warning lamp with magnetic base.



80413

**HALOGEN LAMPS**

- Portable work lamp operates from a cigarette lighter receptacle and features a magnetic base with 80 lbs. of pull-off force, 15 feet of cable, and a built-in switch.
- Perfect for farmers, contractors, utilities, truckers, sportsmen, or emergency uses.
- Sealed beam construction.

80413

3" x 5" Flood lamp with handle.

80510

3" x 5" Spot lamp with handle.

Handle also sold separately as

80364 (works with any Stewart Warner lamp).



70744

**FLUSH MOUNT**

- Flush mounted design is ideal where clearance might be a problem.
- Well suited for installation in grilles, panels, and other such locations.

Part Number	Rated Voltage	Wattage	Beam Pattern	Termination
70744	12V	50W	Trap 35° x 35°	2 1/4" Male Blades
72769	24V	60W	Flood 80° x 30°	2 1/4" Male Blades



79550

**HOBBS EMERGENCY LIGHTING PRODUCT**

The magnetic trouble light consists of a lamp assembly with an 18-foot power cord. It features a smooth-running reel enclosed in a tough, reinforced nylon housing with built-in ON-OFF switch.

**Features and Benefits:**

- Two lights in one—a compartment lamp and an emergency or trouble lamp.
- Eliminates the distress you feel when you discover your flash-light doesn't work.
- Designed to withstand shock, vibration, dust, corrosion and extreme temperatures.
- Wires easily to a 12 VDC power source.
- Includes mounting hardware and installation instructions.

**Specifications:**

**Electrical:** 12 VDC

**Bulb:** Bayonet-base 9.9 candlepower

**Cable:** 18 feet, 20 gauge

Order Data	
Part Number	Description
79550	Packaged Lamp



873128



873159



366ACM  
BEZEL ONLY



366ACN  
HOUSING ONLY



830540 SERIES

4 GC PANEL

Standard panel includes a voltmeter, fuel level, water temperature and oil pressure gauges.

- One-piece, water and dust resistant, front-serviceable, snap-on bezels and lenses.
- Front mounted instruments and lenses with internal back lighting.
- Patented housing and molded-in circuit plate.
- Single interlocking harness connector for all 4 GC functions.
- Rugged plug-in Bi-Torque® gauges.
- Illumination lights serviceable from front and back.
- Easy-to-read green and white graphics.
- Available in 12V and 24V applications

Part Number	12V	Sender	12V Replacement Gauges	
873128	Vertical		(V)876042	10-16V Volt
873129	Horizontal		(H)876043	
		391/392 Series	(V)878089 (H)878090	240 ohm Fuel
		280EC	(V)880123 (H)880124	100-240°F Temp
		279A	(V)883106 (H)883107	0-80 psi Pressure
Part Number	24V	Sender	24V Replacement Gauges	
873158	Horizontal		(H)876052	20-32V Volt
873159	Vertical		(V)876053	
		391/392 Series	(H)878096 (V)878097	240 ohm Fuel
		280EC	(H)880137 (V)880138	100-240°F Temp
		279B-F	(H)883116 (V)883117	0-100 psi Pressure
Optional Accessories				
366ACM – For 3 3/8" Diameter tachometer or speedometer				
366 ACN – Module housing for flashers.				
830540 Series – Component flashers for 366ACN Module.				
(Assortment of component flashers available for various functions) Use 366SX Light Kit. (366SX24 for 24V)				
Senders				
Receiver unit - Press. intended for use with S.W. standard 240 ohm rheostat. See page 23.				
Receiver unit - Temp. intended for use with 280EC sender.				
Receiver unit - Fuel intended for use with S.W. standard 240 ohm rheostat. See page 22.				

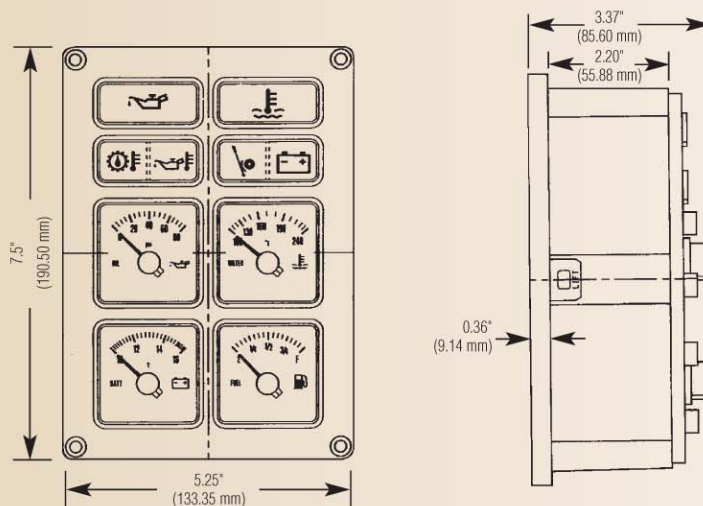





82682



550KM



82459



82681



82336-96



368P-D

**HAND-HELD TACHOMETER**

82682

0-4000 rpm clockwise and counterclockwise. 3" diameter and 4" long used for direct measure on rotating shaft.

412850 12-inch ext. shaft

412850-1 3-inch ext. shaft

96798 Cone rubber tip

96799 Cup rubber tip

**LOW SPEED SPEEDOMETER**

550KM

0-10 mph 2.95" diameter with internal lighting

366WL

Low Speed Kit includes 550KM plus 108" flexshaft, mounting and tire take-off.

**MINI PANEL**

82459

Includes voltmeter, electric water temperature and electric oil pressure gauges in a 4 1/8" w x 2" h x 2" d panel.

**Kit Contains:**

1/8" temperature sender

1/2" and 3/8" adapter nuts

1/8" pressure sender

1/4" adapter

10 mm male female adapters

2 3/4" extension for oil pressure sending unit

**RECORDING BITUMETER**

82681

For accurate, economical road resurfacing and oiling. Measures vehicle speed in FEET per minute. Face dial is black, 4" dia., with white numerals and adjustable, static orange pointer.

**PRESSURE TEMPERATURE**

82336-96

Heavy Duty gauge with 2 1/16" diameter case. 0-150 lbs. pressure scale and 110°-260° temperature range. 96" of temperature tubing. Tubing kit must be ordered separately. See page 37.

**AIR PRESSURE WITH WARNING LIGHT**

368P-D

Mechanical gauge is equipped with a warning light. 3 3/8" diameter dustproof steel case. Chrome bezel. Chimney lighting. Positive or negative ground.



289H-F MOUNTING CUP



366MP-F MOUNTING CUP

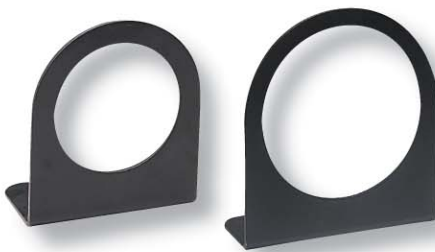

289F-F

289E-F

CUPS AND BRACKETS

5" Tachometer Cup 289H-F

Black ABS plastic cup with stainless strap and black anodized aluminum base. (Gauge not included.)

2 5/8" Cup Mounting Kit 366MP-F

Black finish, includes Cup, Base, Strap and Hardware. (Gauge not included.)

"L" Type mounting bracket

Heavy gauge steel painted flat black to reduce glare.

3 3/8"	289F-F
5"	289E-F

PANELS

Die cast is black with optional wood grain overlay included. Plastic is Noryl black plastic.



813642-F

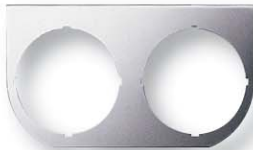

814143-F



289B

	Chrome	Chrome	Die Cast	Plastic
	2 1/16"	2 5/8"	2 1/16"	2 1/16"
1 Hole	817825-F	811659-F	289B	288A *
2 Hole	814143-F	813877-F	289C	287A *
3 Hole	811653-F	813642-F	289D	286A *



288A MOUNTING KIT (GAUGE NOT INCLUDED)



287A

\* No longer available when stock is exhausted.





82638

**PEDESTAL TACH, 0-9000 RPM, 3 3/4" DIAMETER**

**82638**

Movable red line.

Operates on all 4, 6, 8 cylinder vehicles with OEM conventional and electronic ignition systems. 12 Volt negative ground. Pointer comes to rest in random position when not energized.



82853-P

**TRACK FORCE 3 3/8" PEDESTAL MOUNT TACHOMETER**

**82853-P**

Black Bezel.

Adjustable shift pointer. 12 volt negative ground, operates with all original equipment ignition systems and most high output racing ignitions without interference. One piece pedestal housing for extra secure dash or console mounting.



82854-P

**TRACK FORCE PEDESTAL MOUNT TACHOMETER**

**82854-P**

Black Bezel.

Compact size (just 3 1/2" high). 12 volt negative ground, one piece pedestal housing. Operates on all original equipment ignition systems and most aftermarket high output systems as well.



82628



82618

**PEDESTAL MOUNT GAUGES**

**82628 Mini Tachometer**

2 1/2" diameter, 3 1/2" high, 0-8000 rpm, 12V negative ground, for 4-,5-,6-, and 8-cylinders. Complete with adjustable red line.

**82618 Electric Tachometer**

3 1/2" diameter, 0-8000 rpm, 12V negative ground, for 4-,6-, and 8-cylinder complete with adjustable red line.



82233

**DIESEL WINGS – WHITE SIX GAUGE KIT**

82669	Speedometer
82671	Tachometer
82473	Electrical Oil Pressure
82477	Electrical Water Temperature
82481	Voltmeter
82471	Fuel



82232

**DIESEL WINGS – BLACK SIX GAUGE**

82670	Speedometer
82672	Tachometer
82474	Electrical Oil Pressure
82478	Electrical Water Temperature
82482	Voltmeter
82472	Fuel



82243

**BEIGE WINGS – FIVE GAUGE KIT**

82612	Speedometer
82530	Electrical Oil Pressure
82531	Electrical Water Temperature
82533	Voltmeter
82532	Fuel



82244

**SILVER WINGS – FIVE GAUGE KIT**

82611	Speedometer
82497	Electrical Oil Pressure
82498	Electrical Water Temperature
82610	Voltmeter
82499	Fuel



82230

**GOLD WINGS FIVE-GAUGE SET**

82230	
82520	Oil Pressure
82521	Water Temperature
82522	Fuel
82499	Volt
82607	Speed

Kits\* feature electric oil pressure, water temperature, fuel level, voltmeter and speedometer (0-160) is electric. All units feature gold-plated bezels.

All panel kits include mounting panels, instructions, and the following:

1. 12V lighting and 6' tubing kit with fittings.
2. 12V lighting and matching senders.
3. All gauges 2 1/16" diameter case.





82222



82225



82226

**GENUINE WINGS ELECTRIC SIX-GAUGE KIT**

82222 Kit Number

82223 Kit Number

White Facial	Description	Case Size	Black Facial
82473	Electric Oil Press	2 1/16"	82474
82477	Electric Water Temp	2 1/16"	82478
82471	Electric Fuel	2 1/16"	82472
82481	Electric Volt	2 1/16"	82482
82659	Electric Tach	3 3/8"	82660
82661	Electric Speed	3 3/8"	82662

\*Kits feature all necessary senders, lighting, instructions, & installation hardware.

**GENUINE WINGS MECHANICAL SIX-GAUGE KIT**

82224 Kit Number

82225 Kit Number

White Facial	Description	Case Size	Black Facial
82475	Mechanical Oil Press	2 1/16"	82476
82479-72	Mechanical Water Temp	2 1/16"	82480-72
82471	Electric Fuel	2 1/16"	82472
82481	Electric Volt	2 1/16"	82482
82659	Electric Tach	3 3/8"	82660
82663	Mechanical Speed	3 3/8"	82664

\*Kits feature all necessary senders, lighting, instructions, & installation hardware.

**GENUINE WINGS FIVE-GAUGE KIT WITH MECHANICAL SPEED**

82226 Kit Number

82227 Kit Number

White Facial	Description	Case Size	Black Facial
82473	Electric Oil Press	2 1/16"	82474
82477	Electric Water Temp	2 1/16"	82478
82471	Electric Fuel	2 1/16"	82472
82481	Electric Volt	2 1/16"	82482
82663	Mechanical Speed	3 3/8"	82664

\*Kits feature all necessary senders, lighting, instructions, & installation hardware.

**GENUINE WINGS FIVE-GAUGE KIT WITH ELECTRIC SPEED**

82228 Kit Number

82229 Kit Number

White Facial	Description	Case Size	Black Facial
82473	Electric Oil Press	2 1/16"	82474
82477	Electric Water Temp	2 1/16"	82478
82471	Electric Fuel	2 1/16"	82472
82481	Electric Volt	2 1/16"	82482
82661	Electric Speed	3 3/8"	82662

\*Kits feature all necessary senders, lighting, instructions, & installation hardware.

**5" GAUGE CLUSTER**

366ACY

Four gauge cluster. 5" diameter case consists of electric oil pressure (0-80 psi), water temperature (100-240°F), voltmeter (10-16V), and fuel level gauges (240 ohm). Includes all necessary senders and hardware.

366ACY-1

WHITE FACE WITH WINGS LOGO



366ACY



82214B72



82215B



82216B



82217B

STANDARD PLUS PANELS WITH EXTERNAL LIGHTING

Gauge Type	Dial	Sales Kit
<b>Single</b>		
Ammeter <sup>1</sup>	60-0-60	82212B
Mechanical Oil Pressure <sup>2</sup>	0-100 psi	82213B
Mechanical Temperature <sup>3</sup>	100-250°F	82214B72
<b>Double</b>		
Ammeter/Oil <sup>4</sup>	60-0-60/0-100 psi	82215B
Oil/Temperature <sup>5</sup>	10-100 psi/100-250°F	82216B
<b>Triple</b>		
Ammeter/Oil/Temperature <sup>6</sup>	60-0-60/0-100 psi/100-250°F	82217B

All panel kits include mounting panels, instructions, and the following:

1. 12V lighting for electrical system charging up to 60 amps.
2. 6' tubing kit with fittings and 12V lighting.
3. 72" capillary. Includes 12V lighting.
4. 6' tubing kit with fittings and 12V lighting.
5. 72" capillary. Includes 6' tubing kit with fittings and 12V lighting.
6. 12V lighting, for electrical system charging up to 60 amps, and 6' tubing kit with fittings.

**WARNING:** The tubing on mechanical temperature gauges is gas-filled and cannot be shortened without damaging the gauge. When power is turned off, pointer may rest at random on electrical gauges.

VOLTAGE ADAPTER

Used to adapt 12VDC Bi-Torque<sup>®</sup> gauges to higher voltage electrical systems.



829525-2D

	24VDC	32VDC
12V gauge	829525-2D	829525-8D
Pyrometers	829525-9D	829525-6D
Tachometer (Non-hourmeter)	82563B	82564B

REPLACEMENT LIGHT KITS

5/8" light hole (metal socket 1" long)

- One Wire 366FK-F
- One Wire 366CH (With mounting bracket)



366CH

5/8" light hole (plastic socket 1" long)

- One Wire 366SZ
- Two Wire 366SX
- Two Wire 366SX24 (24 Volt)



366SX

1/2" light hole (metal socket 1" long)

- One Wire 82551
- Two Wire 82550





82553-F



82562-F



83066

**TUBING KITS**

**Pressure Kits**

Contains:

- 1/8" female PT nut
- 1/8" male PT nut
- 1/4" adapter nut

	Part Number
6 ft. tubing	82553-F
16 ft. tubing	366HM-F

**Vacuum Kits**

Contains gauge to hose adapter nut, "T" fitting and 6 ft. hose.

**82562-F**

- 1/8" female hose adapter nut
- 3/16" "T" to fit 5/32" I.D. rubber tubing

**Pitot Tube Kit**

Pitot tube features an off balance knife-edged blade which reduces the possibility of obstruction from weeds and other objects.

**83066**

**ADAPTER NUT KITS**

**366NK Kit Mechanical Temperature**

Includes: 8 - 72446-F 2 - 90567 2 - 95527 4 - 428819-F

**82512 Kit Metric Mechanical Temperature**

Includes: 3 - 82572 4 - 82573 3 - 82574

**366ST-F Metric PSI**

Includes: 1 - M10 x 1 1 - M12 x 1.5 1 - M14 x 1.5

**82561-F Kit Japanese PSI**

Includes: 1 - 1/8-28 BSP male 1 - 1/8-28 BSP female

**ADAPTER NUTS**

Standard	Metric	Empirical Metric
<b>Temperature Senders</b>	<b>Temperature Senders</b>	
<b>822650D</b> 1/8" ID to 3/8" OD	<b>832353D</b> 1/8" NPTF to M14x1.5 OD	
<b>822651D</b> 1/8" ID to 1/2" OD	<b>832354D</b> 1/8" NPTF to M16x1.5 OD	
<b>822652D</b> 1/8" ID to 1/4" OD	<b>832602D</b> 1/8" NPTF to M18x1.5 OD	
<b>Pressure Senders</b>	<b>Pressure Senders</b>	<b>Pressure Senders</b>
<b>835251D</b> 1/8" ID to 1/4" OD	<b>824520D</b> 1/8" NPTF ID to M10x1K OD	<b>825612D</b> PT 1/8"-28 JIS Male
	<b>824521D</b> 1/8" NPTF ID to M12x1.5 OD	<b>832855D</b> PT 1/8"-28 JIS Female
	<b>824522D</b> 1/8" NPTF ID to M14x1.5 OD	
<b>Mechanical Water Temperature</b>	<b>Mechanical Water Temperature</b>	
<b>428819-F</b> Steel 5/8"-18 ID to 1/4" NPTF OD	<b>82572</b> 5/8"-18 ID to M14x1.5 OD	
<b>72446-F</b> Steel 5/8"-18 ID to 3/8" NPTF OD	<b>82573</b> 5/8"-18 ID to M16x1.5 OD	
<b>408550-D</b> Brass 5/8"-18 ID to 3/8" NPTF OD	<b>82574</b> 5/8"-18 ID to M18x1.5 OD	
<b>412208-F</b> Brass 5/8"-18 ID to 1/2" NPTF SAE Short OD		
<b>90567</b> Brass 5/8"-18 ID to 1/2" NPTF OD		
<b>95527</b> Brass 5/8"-18 ID to 5/8" NPTF OD		



82050



235A-D



82055

**ELECTRIC PUMPS**

Pumps assure quick starts, eliminate surging, flooding, and starving. All pumps assure battery-saving quick starts by delivering gas the instant ignition switch is turned on.

The 82050 Series is a powerful piston type pump which brings solid state reliability to fuel pumps. One moving part. Built in filters eliminate the need for other filters in line: microcarbon filter dissipates water; magnetic filter traps metallic particles. Gas line connection 1/4" internal PT.

235 Series has a built-in screen. Gas line connection: 1/8" internal PT. Not to be used with alcohol based fuels.

**82050 Series**

**Part No.:**

82050  
12V neg. grd. 7 psi

82051  
12V neg. grd. 5 psi

82052  
12V pos/neg. grd.  
double insulated 7 psi

82054  
24V pos/neg. grd. 7 psi

**235 Series**

**Part No.:**

235A-D  
12V pos/neg. grd. 5 psi

235B-D  
6V pos/neg. grd. 5 psi

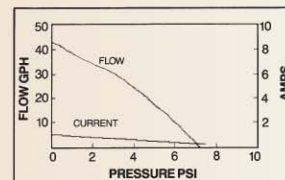

82050-52-54

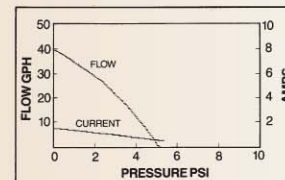

82051

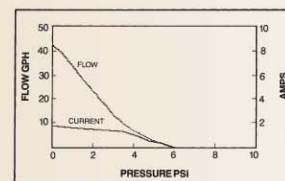

235A-D, 235B-D

**MARINE APPLICATIONS**

Corrosion resistant to prevent leakage. No possibility for accidental grounding. Approved by Underwriters Laboratories, and U.S. Coast Guard regulations for diesel applications.

**Part No.:**

82055  
12V pos/neg. grd. 7 psi

82057  
12V pos/neg. grd. 4 psi

\*Recommended safety switch:  
76579-4.

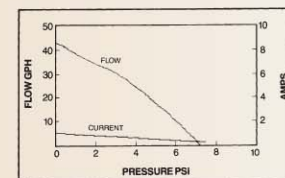

82055

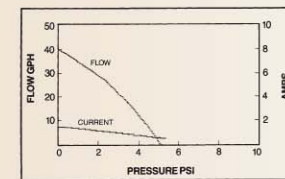

82057





82623B

**82623B SENDER (HALL EFFECT)**

7/8"-18 Thread. 8 pulses per rev (Square Wave).

Connects to mechanical shaft take-off. **Requires 12VDC input.** Comes with .187 Tang tip. Maximum rpm 3,500. One sender will operate two tachometers or two speedometers.

Sender extension 23/8" Long: 103402

(3-wire hook-up) .152 Clutch 814011  
 .187 Clutch 814012



366ADB

**366ADB FORD QUICK DISCONNECT ADAPTER**

Must order 82623B sender separately.

**SENDER 82646 (MAGNETIC)**



82646

Flywheel ring application for tachometer. Tone wheel application for speed. Thread size 3/4"-16 UNE. One sender will operate two tachometers or two speedometers.



82565-F

**82565-F SENDER**

Use with gasoline tachometers that connect to mechanical shaft take-off on distributors or magnetos. **No voltage input required.** Easy two-wire hook-up. Comes with .104 tip.

Available Tips	
.203 Tang	82624
.187 Tang	82625
.152 Tang	82626
.104 Sq.	82629
(order separately)	



407010-F

**RIGHT ANGLE ADAPTER FOR FLEXSHAFTS**

Clockwise 1:1 5/8-18 .104 Sq. 407010-F  
 Counterclockwise 1:1 5/8-18 .104 Sq. 411335-D



407616

**SHUNT**

For use on ammeters requiring external shunt.

813489	60 AMP
407616	100 AMP
413717	150 AMP
413717	300 AMP



15570



403FL

**HOBBS HEAVY DUTY FLASHERS**

Equipped with a spring mass drive motor, the flashers provide up to 10 times the service life of conventional thermal flashers and continue to operate even when the voltage in a 12-volt system drops as low as 9 VDC.

**Features and Benefits:**

- Electro-mechanical (spring mass) motor.
- Silver alloy contacts.
- 1/4-inch blade, brass terminals.
- Polypropylene housing.
- Conforms to Federal Motor Vehicle Safety Standard (FMVSS) 108.
- Exceeds SAE J-590B and SAE J-945 specifications.
- Adapter and extension terminals to convert from a square to a round mounting base.

**Voltage Range:** 9 - 16 VDC (12 VDC rated)  
18 - 32 VDC (24 VDC rated)

**Temperature Range:** -40 to +180°F

**Terminals:** X = Battery P = Pilot L = Load

**Flash Rate:** 60-120 cpm

Order Data				
Voltage	Terminals	Type	Part Number	Compatible Part Number
12V	2	ears	15570-01	13600-01
12V	2	no ears	400FL*	
12V	3	ears	15571-01	15513-01
12V	3	no ears	403FL	
24V	2	ears	13610-01	
24V	3	ears	15550-01	
Individually Boxed				
* Part number 400FL includes an adapter and extension terminals to convert it from a square to a round mounting base.				

**WARNING DEVICES**

**420125-F**

12VDC Warning Light

**825104-D**

Audio-Visual/Light and Buzzer

**366TJ**

Includes 825104-D with 364L-F and 83307 switches  
(See page 24)



420125-F

825104-D

**IGNITION SWITCH**

**370T-D**

Mounts in 3/4" hole 12VDC



370T-D

\* No longer available when stock is exhausted.



**BULK CORE AND CASING AND SPECIAL TOOLS**

Reliable instrument performance depends upon reliable flexible shaft performance. Stewart Warner offers a choice of replacement shaft core and casing products in a variety of lengths and widths.

**PACKAGED UNIVERSAL CORE, .130" DIAMETER**

Part Number	Direction of Winding	Length
130B81D	LH	81"
130B114D	LH	114"

**GALVANIZED STEEL**

Bulk Outer Casing

Size	With Vinyl Cover	With Non-Skive Cover	Without Vinyl Cover
.243"	813783-100	—	98578-100
.445"	816647-100	833805-100	20468-100

**MULTI-STRAND STEEL**

Bulk Inner Core

Diameter	Part Number <sup>1</sup>
.130" Left Lay	418614-100,-500,-1000
.150" Left Lay	825128-115,-550,-1100
.187 Right Lay	418615-50,-115,-550

<sup>1</sup>XXXX" indicates length in feet

**DUAL PLASTIC CASING**

820905-100

Dual Plastic Casing

.333" 100 ft. Reels

.175" I.D.

**SWAGING AND CUTTING FIXTURE COMPONENTS**

136374-6T

Base Model

137374-10T

Swaging Tool Detail

- Cut bulk core stock
- Swage .104 square on .130 core
- Crimp a tip securely to a core
- Swage .124 square on .150 core

429430

Ferrule Crimping Tool

- Compact tool design for crimping various Ferrules to bulk casing sizes .243, .297, .445

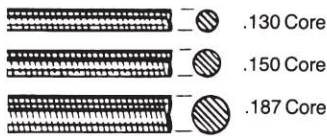
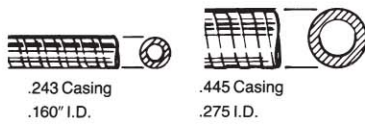

136374-6T

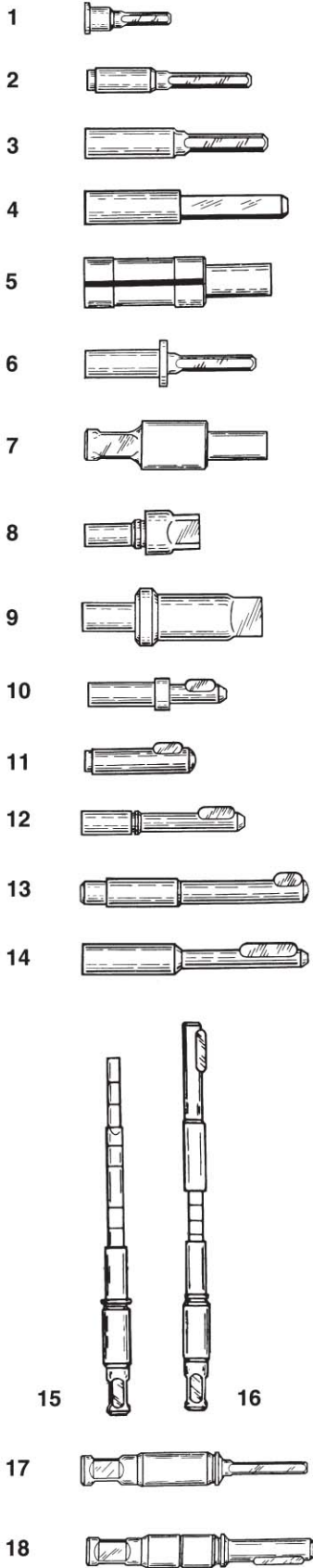

COMPENSATING TIPS

End Size	Illustration Number	Length	Part Number	Cutting Deduction
<b>For .130" Core</b>				
.104 square	6	1 5/32"	823114*	23/32"
.104 square	1	13/18"	418035	1/16"
.124 square	2	1 7/16"	60457*	1"
.152 tang	12	7/16"	400211*	1 3/64"
.152 tang	10	1 5/32"	63684	23/32"
.187 tang	10	3/16"	104461*	3/4"
.187 sq. hole	8	1 1/32"	402210*	—
.203 tang	10	1 3/16"	63317	3/4"
.203 tang	11	1"	33710	9/16"

<b>For .150" Core</b>				
.104 square	3	1 1/2"	65002	1 1/16"
.104 square	6	1 5/32"	65658	23/32"
.104 square	6	1 21/64"	95115	63/64"
.104 square	6	1 1/2"	425451 <sup>1</sup>	1 1/16"
.104 sq. hole	7	1 1/2"	66001	—
.124 square	2	1 7/16"	98984	1"
.124 square	6	1 5/32"	37683*	23/32"
.150 square	3	1 3/4"	421643	1 1/16"
.152 tang	14	1 7/8"	408758	1 11/32"
.152 tang	12	1 7/8"	421795	1 23/64"
.1835 square	4	23/32"	428827*	1 3/32"
.187 tang	13	2"	64339	1 9/16"
.187 tang	10	1 17/32"	427828	1 3/32"
.187 sq. hole	9	1 9/16"	96833	—
.187 sq. hole	8	1 1/32"	409353	—
.187 tang hole	5	1 9/16"	96127	—
.293 tang	12	2"	13909	1 9/16"
.203 tang hole	5	1 9/16"	78869	—

<b>For .187" Core</b>				
.104 square	3	1 1/2"	426106*	1 1/16"
.104 square	6	1 35/64"	405137*	1 7/64"
.104 sq. hole	7	1 1/2"	426056*	—
.150 square	3	1 3/4"	105133*	1 1/16"
.152 tang	14	2"	415996	1 5/16"
.152 tang hole	5	1 13/16"	406908	—
.1835 square	4	1 25/32"	414677	1 3/32"
.187 tang	13	2"	101254	1 5/16"
.187 tang	10	2"	426108	1 5/16"
.187 tang	10	2"	811192	1 5/16"
.187 sq. hole	8	1 1/4"	418811*	—
.187 sq. hole	9	1 9/16"	98877*	—
.187 tang hole	5	1 13/16"	101983	—
.193 sq. hole	9	1 9/16"	414676*	—
.203 tang	14	2"	32912	1 5/16"
.203 tang hole	5	1 13/16"	39041	—

<sup>1</sup> Ford shaft, thin-walled.

End Size	Illustration Number	Length	Part Number	Cutting Deduction
.104 square	17	2 7/32"	818749	31/32"
.104 square	17	2 57/64"	820152	1 41/64"
.124 square	17	2 7/32"	819468*	31/32"
.150 square	17	2 7/32"	817767	31/32"
.150 square	15	4 1/4"	820220-1*	3"
.152 tang	18	2 7/32"	818750	31/32"
.187 tang	18	2 7/32"	817769	31/32"
.193 square	17	2 57/64"	820153*	1 41/64"
.203 tang	18	2 7/32"	817759	31/32"
.203 tang	16	4 3/8"	820219-1	3 1/4"

\* No longer available when stock is exhausted.



FERRULE SPECIFICATIONS

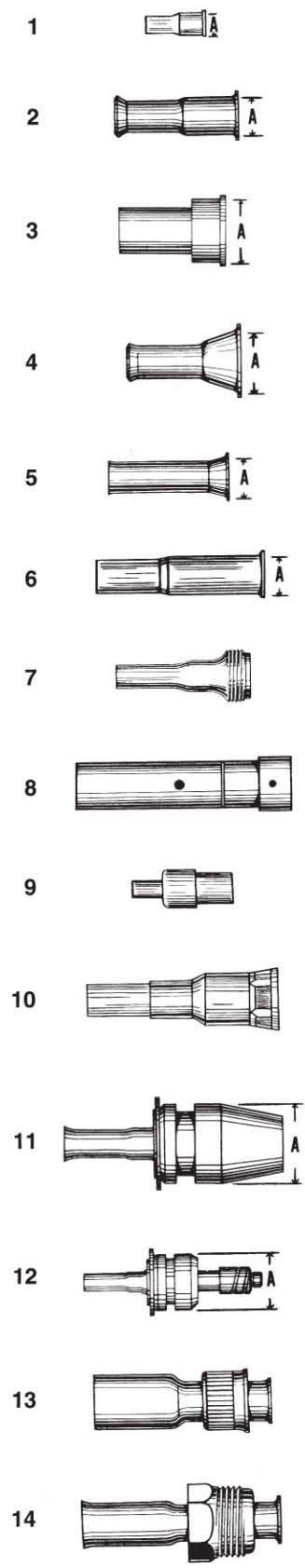

**For .243" Diameter Casing**

Illustration Number	Length	Description	Part Number	"A" Dimension
1	1 5/16"	Ferrule	95374*	13/32"
1	1 5/16"	Ferrule	810809*	13/32"
2	1 3/8"	Ferrule	94353*	13/32"
3	1 5/16"	Ferrule	94354	43/64"
7	2 1/4"	Ferrule	69930	7/8-18 Thd.

**For .333" Diameter Casing**

Illustration Number	Length	Description	Part Number	"A" Dimension
1	1 3/8"	Ferrule	820733-3	7/16"
4	1 5/16"	Ferrule	820733-10	43/64"
1	1 7/8"	Ferrule	820734-6	7/16"
6	2 1/4"	Ferrule & Bushing	820734-5	43/64"
7	2 1/4"	Ferrule	820733-33	7/8-18 Thd.
10	2 1/8"	(G.M. Snap-On)	823813	—
9	2 5/16"	Ferrule (Ford Snap-On)	821146-1	—
12	3 5/8"	Ferrule & Shaft	824012	7/8"

**For .445" Diameter Casing**

Illustration Number	Length	Description	Part Number	"A" Dimension
1	2 11/64"	Ferrule & Bushing	820211-2	1/2"
4	1 1/2"	Ferrule & Bushing	400514	1/2"
4	2"	Ferrule	820211-13	1/2"
2	2"	Ferrule	820500-4	1/2"
5	1 1/2"	Ferrule	820500-3	1/2"
5	2"	Ferrule & Bushing	820211-1	1/2"
5	2"	Ferrule & Bushing	820211-4	1/2"
6	2 5/8"	Ferrule	820500-7	33/64"
7	2 1/4"	Ferrule	820500-11	7/8-18 Thd.
11	2 19/32"	Ferrule & Extension	820210-2*	7/8"
13	2"	Ferrule & Nut Assembly	820214-6	5/8-18 Thd.
13	2"	Ferrule & Nut Assembly	820214-1	5/8-18 Thd.
13	2"	Ferrule & Nut Assembly	820214-2	5/8-18 Thd.
13	2"	Ferrule & Nut Assembly	820214-4	5/8-18 Thd.
14	1 15/64"	Ferrule & Nut Assembly	820213-3*	5/8-18 Thd.
14	2 15/64"	Ferrule & Nut Assembly	820215-1	3/4-18 Thd.

NUT SPECIFICATIONS

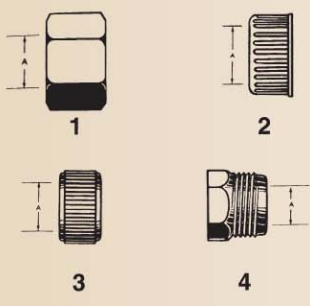

"A" Dimension	Thread Size	Illustration Number	Part Number
7/16"	3/4-20	4	820346-16
29/64"	3/4-20	3	820346-11*
29/64"	3/4-20	4	820346-17*
15/32"	5/8-18	1	802346-1
15/32"	5/8-18	2	820346-4
38/64"	3/4-20	3	820346-12*
11/16"	7/8-18	1	820346-23
11/16"	7/8-18	2	820346-22

\* No longer available when stock is exhausted.

A Straight-thru drive-joint used for correcting instruments that register fast or slow due to change in tire size, axle ratio or transmission gears on a passenger car or truck. Die-cast housing with a very compact design that can be completely assembled and repaired in the field. Call for available ratios.

**Description**

Drive Joint Kit 82903 contains parts which are common to all Model 777 Series drive joints. It contains almost enough parts to make one drive joint but will require parts from two additional kits to be complete. Kit 82953 contains uncommon parts for the 777 Series in popular quantities and enough for several drive joints. The gears are available in a third kit, 82954.

All parts available individually.

**777 SERIES**

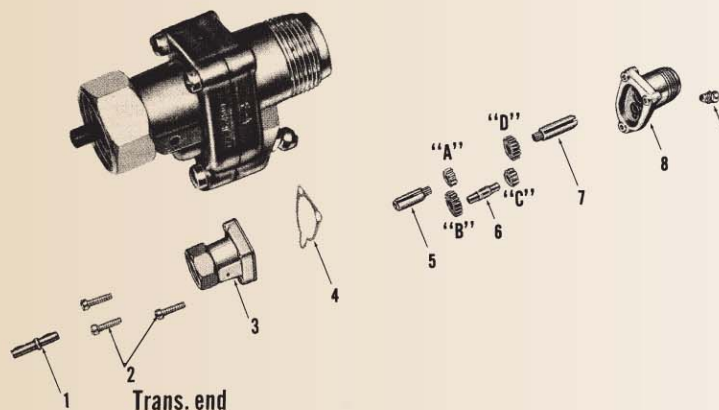

**82903 DRIVE JOINT KIT**

Kit contains common parts for a single 777 drive joint. Must be used with parts from kit 82953 to assemble a complete unit.

Ref. No.	Part No.	Quantity
2	170509	(3)
3	400017	(1)
4	400014	(1)
5	817552	(1)

Ref. No.	Part No.	Quantity
6	13787	(1)
8	408712	(1)
	1641-B	(1)
	433326	(1)

**DRIVE JOINT PARTS**

Kit contains uncommon parts of the 777 drive joint. Medium-duty straight-through unit. Kit will build or repair every model offered.

Ref. No.	Part No.	Quantity
1	101451	
1	101452	
1	428798	
2	101453	
7	400011	

Ref. No.	Part No.	Quantity
7	400012	
7	400013	
7	408730	
7	428799	
	832465	

**DRIVE JOINT GEAR**

A new gear kit which contains all the gears used on models 666 and 777.

Quantity	Part Number
	816487
	917488
	816474
	816475
	816476
	816477
	816478
	816483
	816493

Quantity	Part Number
	832212-16
	816480
	816482
	816494
	832212-14
	816472
	816473
	816479
	816481
	816491
	816492



This is an off-set drive joint used for correcting an instrument that registers fast or slow because of a change in tire size, axle ratio, or transmission gears on a passenger car or truck. Call for available ratios.

**Description**

Drive Joint Kit 82901 contains parts which are common to all Model 666 Series Drive Joints. It contains almost enough parts to make one drive joint but will require parts from two additional kits to be complete. Kit 82951 contains uncommon parts for the 666 Series in popular quantities and enough for several drive joints. The gears are available in a third kit, 82954.

All parts available individually.

666 SERIES

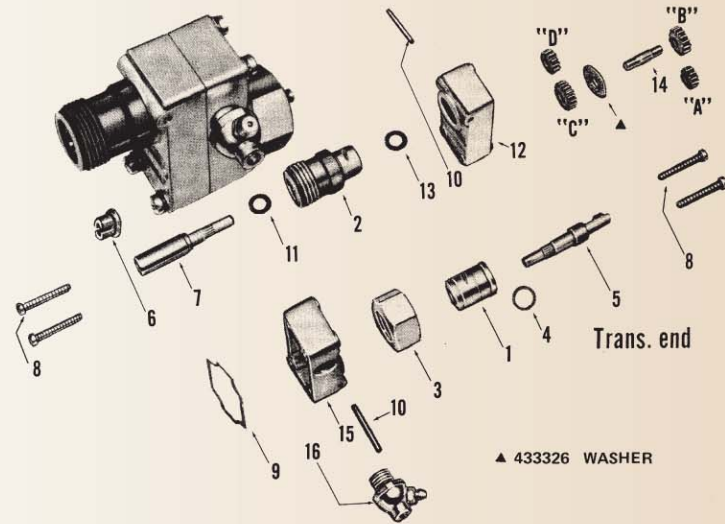

82901 DRIVE JOINT KIT

Kit contains common parts for one 666 drive joint. Together they cover all of the models offered. This is a medium-duty drive joint for light trucks, automobiles, and boats.

Ref. No.	Part No.	Quantity
1	830561	(1) Sleeve
2	15204	(1) Sleeve
3	820346-20	(1) Nut
8	171885	(4) Screws
9	13144	(1) Gasket
10	13116	(2) Pin

Ref. No.	Part No.	Quantity
11, 13	844	(2) Washer
12	101487	(1) Case (Trans.)
14	13787	(1) Intermediate Shaft
15	14477	(1) Case (Shaft)
17	433326	(1) Washer
	1940-B	(1) Alemite Fitting*

\*Not available separately

DRIVE JOINT PARTS

Kit contains uncommon parts of the 666 drive joint series for repairing and servicing.

Ref. No.	Part No.	Quantity
4	832465	(20) Washer
5	15202	(10) Drive Shaft
5	90062	(4) Driven Shaft
5	97010	(2) Drive Shaft

Ref. No.	Part No.	Quantity
5	417052	(4) Drive Shaft
7	64701	(10) Driven Shaft
7	69503	(6) Driven Shaft
7	96097	(2) Driven Shaft
7	831186	(6) Sleeve

DRIVE JOINT GEAR

A new gear kit which contains all the gears used on models 666 and 777.

Quantity	Part Number
	816487
	816488
	816474
	816475
	816476
	816477
	816478
	816483
	816484
	816493

Quantity	Part Number
	832212-16
	816480
	816482
	816494
	832212-14
	816472
	816473
	816479
	816481
	816491
	816492

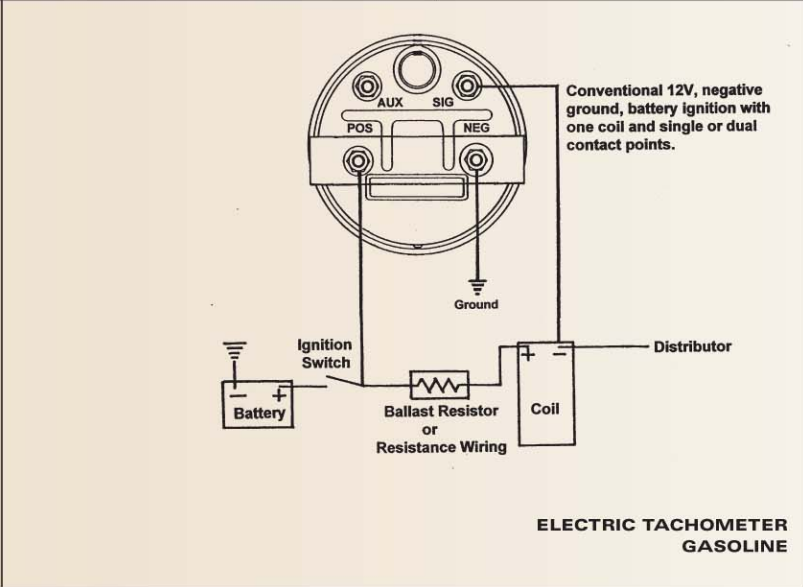
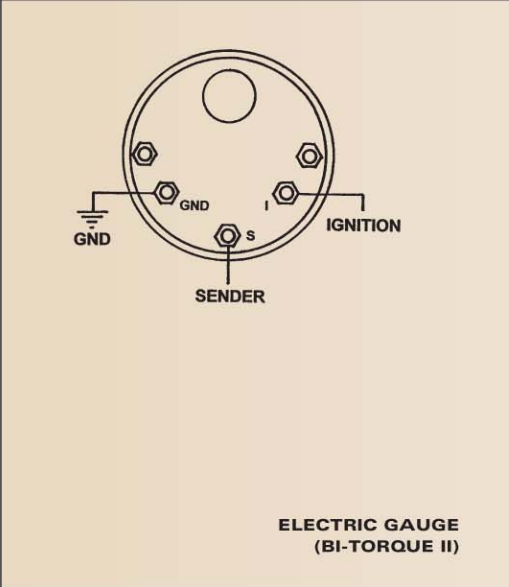
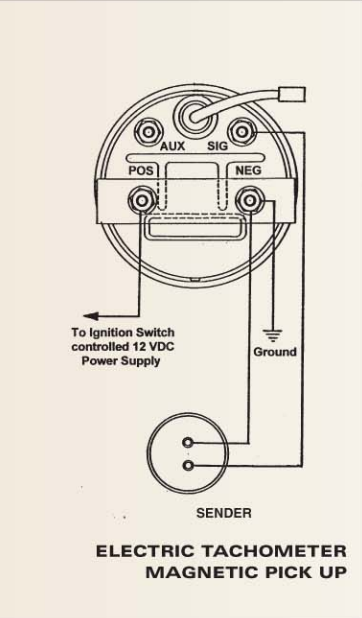
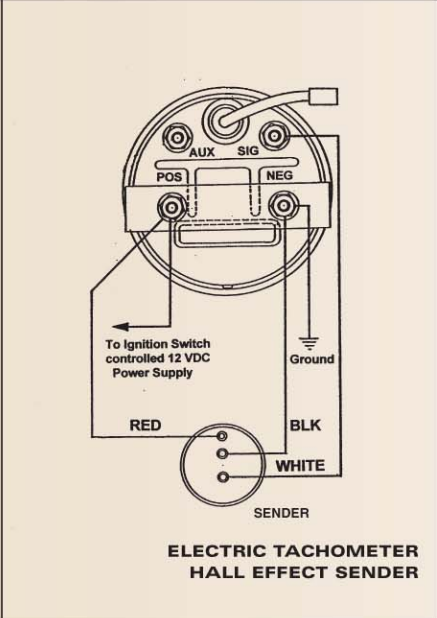
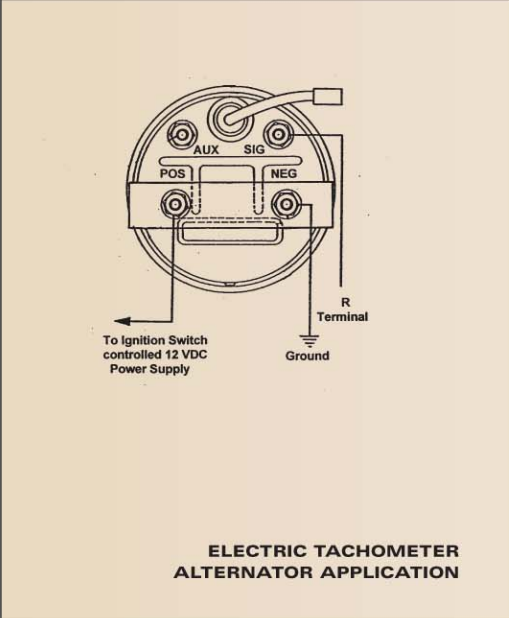
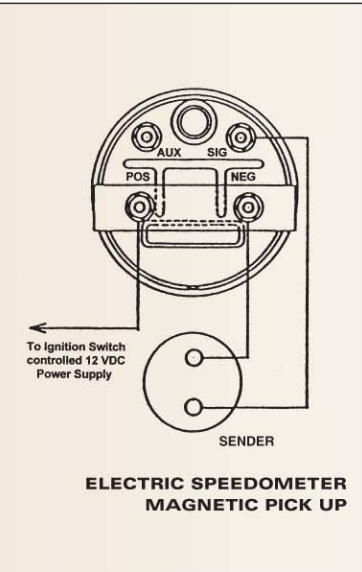
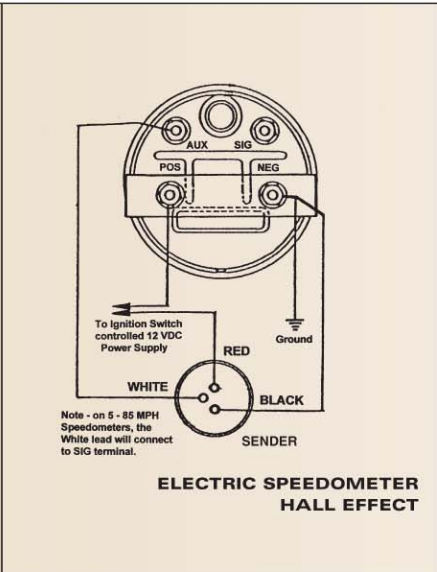
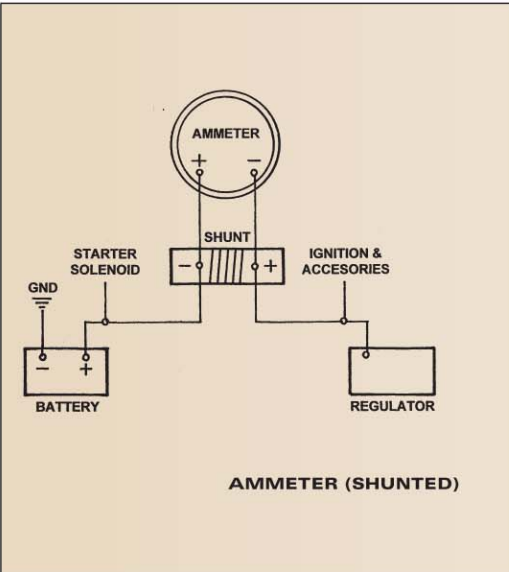



MODEL NUMBER ORDER

Model #	Sales Kit #	Model #	Sales Kit #	Model #	Sales Kit #	Model #	Sales Kit #	Model #	Sales Kit #	Model #	Sales Kit #
323C	82505	391B	391B-F	460DE	82714	467DF	82352	479BF	82124	481LT	82600
334AA	334AA-D	391C	391C-D	460EP	82868	467DP	82306	479BH	284BP	481MC	82605
334AB	334AB-D	391D	391D-D	460ER	82865	467DR	82307	479BJ	82135	482CY	82645
334AD	334AD-D	391PX	391PX-D	460EZ	82885	467DS	82308	479BL	82414	482CZ	82637
334AZ	82503	392A	392A-F	460F	284L	467EM	82374	479BN-BL	83057	482DA	82642
334DA	82510-F	392B	392B-F	460FA	82888	467EN	82375	479BN-GY	83058	482DL	82658
334F	280EC	392C	392C-D	460H	284T	467ER	82114	479BN-PR	83056	482DM	82656
334H	334H-D	392D	392D-D	460R	284AE	467ES	82115	479BN-RD	83055	482DN	82661
334H	280ED-F	411AB	82504F	462AP	82126	467FB	82355	479BN-TL	83059	482DP	82662
334J	280EE-F	411J	279A	462AX	82132	467HH	82389	479BN-WH	83054	482DS	82603
334K	334K-D	411J	82511	462BA	82349	467HK	82390	481BN	82618	482DT	82669
334L	334L-D	411K	279B-F	462BD	82304	467HZ	82731	481CA	82619	482DW	82670
334M	334M-D	411L	279D	462BE	82305	467JA	82732	481CB	82620	482DX	82698
334N	334N-D	411M	279C	462BF	82333	467JL	82739	481DJ	82633	482EB	82896
334P	334P-D	411X	82514	462BK	82113	467JM	82730	481DM	82638	482ED	82601
334R	334R-D	411Y	82501	462BL	82116	467JN	82740	481FW	82800	482EE	82604
334T	280EH-F	412J	82892	462BP	82354	467JS	82477	481FX	82850	482EH	82606
337BF	82200	412K	82893	462BR	82358	467JT	82478	481HA	82853	486X	82384
337BH	82201	412M	82894	462BX	82387	467JW-BL	83003	481HH	82162	490AAW	82372
337BJ	82202	412L	82895	462BY	82388	467JW-GY	83004	481HJ	82164	490AAX	82373
337DK	82212B	413AB	83312	462CA	82729	467JW-PR	83002	481HK	82163	490ABA	82362
338AE	284A	413AM	83301	462CB-BL	83045	467JW-RD	83001	481HL	82165	490ABB	82363
338CM	82108	413AX	83309	462CB-GY	83046	467JW-TL	83005	481HX	82621	490ABC	82634
338CX	82700	413AY	83305	462CB-PR	83044	467JW-WH	83000	481HY	82622	490ABD	82365
338FS	82713	413BR	83306	462CB-RD	83043	467JX-BL	83027	481HZ	82820	490ABJ	82380
338JE	82855	413BY	83302	462CB-TL	83047	467JX-GY	83028	481JA	82873	490ABL	82742
338JL	82875	413CL	83313	462CB-WH	83042	467JX-PR	83026	481JF	82172	490ABM	82392
338JP	82310	413CM	83314	462CF	82728	467JX-RD	83025	481JL	82802	490ABN	82393
338JR	82311	413CP	83303	462CK	82473	467JX-TL	83029	481JM	82822	490ABP	82741
338JS	82313	413D	83300	462CL	82474	467JX-WH	83024	481JN	82803	490ABR	82743
338JY	82736	413E	83304	462CM-BL	83021	470DY	82709	481JP	82823	490ABY	82475
338JZ	82737	413F	83307	462CM-GY	83022	470EF	82862	481JW	82170	490ABZ	82476
338KA	82748	413G	83310	462CM-PR	83020	470EM	82882	481JX	82171	490ACB-BL	83033
338KK	82398	413P	83308	462CM-RD	83019	471C	284AJ	481KB1	82643	490ACB-GY	83034
342KS	82209	413W	83311	462CM-TL	83023	472AA	82110	481KB2	82644	490ACB-PR	83032
346JB	82210	433084	83066	462CM-WH	83018	472AF	82701	481KC1	82635	490ACB-RD	83031
352AT	82207	442057	82410	462CN	82397	472CA	82343	481KC2	82636	490ACB-TL	83035
352AW	82208	455AW	82111	462CR-BL	83070	472CC	82361	481KD1	82640	490ACB-WH	83030
355B	82411	455BF	82712	462CR-GY	83071	472CD	82359	481KD2	82641	490ACC-BL	83051
361CB	82326	455DP	82863	462CR-PR	83069	472E	284AA	481KH	82647	490ACC-GY	83052
361CC	82327	455ED	82883	462CR-RD	83068	472F	284AB	481KJ	82648	490ACC-PR	83050
362AH	362AH-D	455L	284M	462CR-TL	83072	472H	284AD	481KK	82649	490ACC-RD	83049
362AJ	362AJ-D	457AS	82125	462CR-WH	83067	472Z	82109	481KL	82650	490ACC-TL	83053
362AN	362AN-D	457AY	82131	462D	284AM	474AA	82112	481KM	82651	490ACC-WH	83048
362BB	362BB-D	457BA	82353	465AJ	284F	474AB	284H	481KN	82164B	490ACL	82396
362CZ	362CZ-D	457BD	82303	465AJ	284AF	474AM	82128	481KP	82171B	490ACM	82483
362DA	362DA-D	457BH	82378	465DY	82706	474BC	82134	481KR	82162B	490ACN	82484
362ES	280EA	457BR	82211	465DZ	82702	474BF	82309	481KS	82170B	490ACP	82487
362ET	280EB	457CC	82386	465EB	82708	474BN	82376	481KX	82655	490ACR	82488
364K	364K-F	457CE	82733	465LP	82715	474CK	82391	481LC	82659	490BS	284E
364L	364L-F	457CF	82734	465NX	82866	474CL	82738	481LD	82660	490BW	284N
366LP	366LP-F	457CH	82735	465NY	82867	474CN	82481	481LE-BL	83039	490BX	284P
366MP	366MP-F	457CJ	82471	465PW	82886	474CP	82482	481LE-GY	83040	490BY	284R
366ST	366ST-F	457CK	82472	465PX	82887	474CR-BL	83015	481LE-PR	83038	490BZ	284S
370T	370T-D	457CL-BL	83009	465R	284J	474CR-GY	83016	481LE-RD	83037	490EX1	284D
385AB	385AB-P	457CL-GY	83010	465S	284K	474CR-PR	83014	481LE-TL	83041	490HC	82710
385B	385B-F	457CL-PR	83008	467AZ	82346	474CR-RD	83013	481LE-WH	83036	490HD	82704
385C	385C-F	457CL-RD	83007	467CK	82127	474CR-TL	83017	481LJ	82671	490JF	82717
386AB	386AB-P	457CL-TL	83011	467CZ	82133	474CR-WH	83012	481LK	82672	490PP	284BF
386B	386B-F	457CL-WH	83006	467DB	82344	475M	82347	481LL	82673	490SP	82725
386C	386C-F	460BD	82705	467DC	82345	475R	82377	481LM	82674	490TS	82130
391A	391A-F	460BT	82711	467DE	82351	479BC	82129	481LN	82699	490TT	82856



**MODEL NUMBER ORDER**

Model #	Sales Kit #	Model #	Sales Kit #	Model #	Sales Kit #
490TW	82857	550AAS	82695	757AN	82682
490TX	82858	550AAX	82697	825104	366TJ
490TY	82864	550ABA	82663	828160-3	82556-1
490XS	82876	550ABB	82664	828160-4	82556-2
490XT	82877	550ABC	82665	828160-5	82556-3
490XW	82878	550ABD	82666	829569	825104
490XX	82884	550BP	550BP-D	830541	82624
490YJ	82348	550HF	550HF-D	832091	82628
490YK	82350	550HH	550HH-D	833929	82854
490ZC	82120	550KM	366WL	834717-2	82213B
490ZD	82121	550PD	82676	834717-3	82214B72
490ZE	82319	550SN	82680	834718-1	82215B
490ZF	82320	550SZ	82677	834718-2	82216B
490ZH	82321	550TA	82678	834719	82217B
490ZJ	82322	550TD	82679	835A	83500
490ZK	82323	550ZR	82872	835B	83501
490ZL	82324	550ZT	82692	835C	83502
490ZM	82325	551AHK	551AHK-D	835D	83503
490ZN	82329	551AHL	551AHL-D	835E	83504
490ZP	82340	551AKM	551AKM-D	835F	83505
491AM	284B	551APP	82683	835H	83506
491AN	284C	551APS	82684	835K	83507
491CH	82703	551AYT	82801	835L	83508
491DS	82383	551AYW	82851	873041	82459
491DW	82859	551AZN	82821	873134	366ACY
491DX	82860	551AZP	82871	878048	82413
491EL	82879	551AZY	82688	878057	82813
491EM	82880	551AZZ	82689	878063	82869
491FE	82381	551BAA	82690	878064	82870
491FF	82382	551BAB	82691	878067	82726
491FH	82394	551BAJ	82696	878068	82727
491FJ	82395	598AP	82152	878073	82833
491FK	82744	598AR	82153	878074	82889
491FM	82749	598CA	82173	878080	82341
491FN	82479	598CC-BL	83063	878081	82342
491FP	82480	598CC-GY	83064	878082	82379
492AP	284AH	598CC-PR	83062	990K	82646
492AZ	82117	598CC-RD	83061	995J	82623B
492CM	82301	598CC-TL	83065	550ZJ	82852
492CR	82718	598CC-WH	83060	411135	411335-D
492CZ	82811	690S	82404	411290	411290-P
492DA	82861	690W	82805	420125	420125-F
492DH	82831	690X	82825	811653	811653-F
492DJ	82881	691AJ	82405	811659	811659-F
492DR	82328	691AW	82806	813642	813642-F
492DT	82745	691AX	82807	813877	813877-F
493AR	82331	691AY	82808	814143	814143-F
493BA96	82336-96	691AZ	82814	817825	817825-F
493CH	82332	691BH	82826	821134	105H-D
493CK	82371	691BJ	82827	821135	106AW-D
493CM	82746	691BK	82828	878065	284BS
497AD	82335	691BL	82834	878066	284BR
497AE	82357	691CB	82406	878075	82890
		691DB	82407		
497AJ	82485	691FB	82408		
497AK	82486	692AE	82809		
497AK	84486	692AF	82810		
497H	82334	692AM	82829		
535AH	535AH-D	692AN	82830		
535AK	535AK-D	692E	82409		
541N	82681	695D	82812		
550AAR	82694	695E	82832		

**SALES KIT NUMBER ORDER**

Sales Kit #	Model #	Sales Kit #	Model #	Sales Kit #	Model #
		366TJ	825104	82162B	481KR
		366WL	550KM	82163	481HK
279A	411J	370T-D	370T	82164	481HJ
279B-F	411K	385AB-P	385AB	82164B	481KN
279C	411M	385B-F	385B	82165	481HL
279D	411L	385C-F	385C	82170	481JW
280EA	362ES	386AB-P	386AB	82170B	481KS
280EB	362ET	386B-F	386B	82171	481JX
280EC	334F	386C-F	386C	82171B	481KP
280ED-F	334H	391A-F	391A	82172	481JF
280EE-F	334J	391B-F	391B	82173	598CA
280EH-F	334T	391C-D	391C	82200	337BF
284A	338CS	391D-D	391D	82201	337BH
284AA	472E	391PX-D	391PX	82202	337BJ
284AB	472F	392A-F	392A	82207	352AT
284AD	472H	392B-F	392B	82208	352AW
284AE	460R	392C-D	392C	82209	342KS
284AF	465AJ	392D-D	392D	82210	346JB
284AH	492AP	411290-P	411290	82211	457BR
284AJ	471C	411335-D	411135	82212B	337DK
284AM	462D	420125-F	420125	82213B	834717-2
284B	491AM	535AH-D	535AH	82214B72	834717-3
284BF	490PP	535AK-D	535AK	82215B	834718-1
284BP	479BH	550BP-D	550BP	82216B	834718-2
284BR	878066	550HF-D	550HF	82217B	834719
284BS	878065	550HH-D	550HH	82301	492CM
284C	491AN	551AHK-D	551AHK	82303	457BD
284D	490EX1	551AHL-D	551AHL	82304	462BD
284E	490BS	551AKM-D	551AKM	82305	462BE
284F	465AJ	811653-F	811653	82306	467DP
284H	474AB	811659-F	811659	82307	467DR
284J	465R	813642-F	813642	82308	467DS
284K	465S	813877-F	813877	82309	474BF
284L	460F	814143-F	814143	82310	338JP
284M	455L	817825-F	817825	82311	338JR
284N	490BW	82108	338CM	82313	338JS
284P	490BX	82109	472Z	82319	490ZE
284R	490BY	82110	472AA	82320	490ZF
284S	490BZ	82111	455AW	82321	490ZH
284T	460H	82112	474AA	82322	490ZJ
334AA-D	334AA	82113	462BK	82323	490ZK
334AB-D	334AB	82114	467ER	82324	490ZL
334AD-D	334AD	82115	467ES	82325	490ZM
334H-D	334H	82116	462BL	82326	361CB
334K-D	334K	82117	492AZ	82327	361CC
334L-D	334L	82120	490ZC	82328	492DR
334M-D	334M	82121	490ZD	82329	490ZN
334N-D	334N	82124	479BF	82331	493AR
334P-D	334P	82125	457AS	82332	493CH
334R-D	334R	82126	462AP	82333	462BF
362AH-D	362AH	82127	467CK	82334	497H
362AJ-D	362AJ	82128	474AM	82335	497AD
362AN-D	362AN	82129	479BC	82336-96	493BA96
362BB-D	362BB	82130	490TS	82340	490ZP
362CZ-D	362CZ	82131	457AY	82341	878080
362DA-D	362DA	82132	462AX	82342	878081
364K-F	364K	82133	467CZ	82343	472CA
364L-F	364L	82134	474BC	82344	467DB
366ACY	873134	82135	479BJ	82345	467DC
366LP-F	366LP	82152	598AP	82346	467AZ
366MP-F	366MP	82153	598AR	82347	475M
366ST-F	366ST	82162	481HH	82348	490YJ



## SALES KIT NUMBER ORDER

Sales Kit #	Model #	Sales Kit #	Model #	Sales Kit #	Model #	Sales Kit #	Model #	Sales Kit #	Model #	Sales Kit #	Model #
82349	462BA	82481	474CN	82666	550ABD	82743	490ABR	82879	491EL	83045	462CB-BL
82350	490YK	82482	474CP	82669	482DT	82744	491FK	82880	491EM	83046	462CB-GY
82351	467DE	82483	490ACM	82670	482DW	82745	492DT	82881	492DJ	83047	462CB-TL
82352	467DF	82484	490ACN	82671	481LJ	82746	493CM	82882	470EM	83048	490ACC-WH
82353	457BA	82485	497AJ	82672	481LK	82748	338KA	82883	455ED	83049	490ACC-RD
82354	462BP	82485	497AJ	82673	481LL	82749	491FM	82884	490XX	83050	490ACC-PR
82355	467FB	82486	497AK	82674	481LM	82800	481FW	82885	460EZ	83051	490ACC-BL
82357	497AE	82487	490ACP	82676	550PD	82801	551AYT	82886	465PW	83052	490ACC-GY
82358	462BR	82488	490ACR	82677	550SZ	82802	481JL	82887	465PX	83053	490ACC-TL
82359	472CD	82501	411Y	82678	550TA	82803	481JN	82888	460FA	83054	479BN-WH
82361	472CC	82503	334AZ	82679	550TD	82805	690W	82889	878074	83055	479BN-RD
82362	490ABA	82504F	411AB	82680	550SN	82806	691AW	82890	878075	83056	479BN-PR
82363	490ABB	82505	323C	82681	541N	82807	691AX	82892	412J	83057	479BN-BL
82365	490ABD	825104	829569	82682	757AN	82808	691AY	82893	412K	83058	479BN-GY
82371	493CK	82510-F	334DA	82683	551APP	82809	692AE	82894	412M	83059	479BN-TL
82372	490AAW	82511	411J	82684	551APS	82810	692AF	82895	412L	83060	598CC-WH
82373	490AAX	82514	411X	82688	551AZY	82811	492CZ	82896	482EB	83061	598CC-RD
82374	467EM	82556-1	828160-3	82689	551AZZ	82812	695D	83000	467JW-WH	83062	598CC-PR
82375	467EN	82556-2	828160-4	82690	551BAA	82813	878057	83001	467JW-RD	83063	598CC-BL
82376	474BN	82556-3	828160-5	82691	551BAB	82814	691AZ	83002	467JW-PR	83064	598CC-GY
82377	475R	82600	481LT	82692	550ZT	82820	481HZ	83003	467JW-BL	83065	598CC-TL
82378	457BH	82601	482ED	82694	550AAR	82821	551AZN	83004	467JW-GY	83066	433084
82379	878082	82603	482DS	82695	550AAS	82822	481JM	83005	467JW-TL	83067	462CR-WH
82380	490ABJ	82604	482EE	82696	551BAJ	82823	481JP	83006	457CL-WH	83068	462CR-RD
82381	491FE	82605	481MC	82697	550AAX	82825	690X	83007	457CL-RD	83069	462CR-PR
82382	491FF	82606	482EH	82698	482DX	82826	691BH	83008	457CL-PR	83070	462CR-BL
82383	491DS	82618	481BN	82699	481LN	82827	691BJ	83009	457CL-BL	83071	462CR-GY
82384	486X	82619	481CA	82700	338CX	82828	691BK	83010	457CL-GY	83072	462CR-TL
82386	457CC	82620	481CB	82701	472AF	82829	692AM	83011	457CL-TL	83300	413D
82387	462BX	82621	481HX	82702	465DZ	82830	692AN	83012	474CR-WH	83301	413AM
82388	462BY	82622	481HY	82703	491CH	82831	492DH	83013	474CR-RD	83302	413BY
82389	467HH	82623B	995J	82704	490HD	82832	695E	83014	474CR-PR	83303	413CP
82390	467HK	82624	830541	82705	460BD	82833	878073	83015	474CR-BL	83304	413E
82391	474CK	82628	832091	82706	465DY	82834	691BL	83016	474CR-GY	83305	413AY
82392	490ABM	82633	481DJ	82708	465EB	82850	481FX	83017	474CR-TL	83306	413BR
82393	490ABN	82634	490ABC	82709	470DY	82851	551AYW	83018	462CM-WH	83307	413F
82394	491FH	82635	481KC1	82710	490HC	82852	550ZJ	83019	462CM-RD	83308	413P
82395	491FJ	82636	481KC2	82711	460BT	82853	481HA	83020	462CM-PR	83309	413AX
82396	490ACL	82637	482CZ	82712	455BF	82854	833929	83021	462CM-BL	83310	413G
82397	462CN	82638	481DM	82713	338FS	82855	338JE	83022	462CM-GY	83311	413W
82398	338KK	82640	481KD1	82714	460DE	82856	490TT	83023	462CM-TL	83312	413AB
82404	690S	82641	481KD2	82715	465LP	82857	490TW	83024	467JX-WH	83313	413CL
82405	691AJ	82642	482DA	82717	490JF	82858	490TX	83025	467JX-RD	83314	413CM
82406	691CB	82643	481KB1	82718	492CR	82859	491DW	83026	467JX-PR	83500	835A
82407	691DB	82644	481KB2	82725	490SP	82860	491DX	83027	467JX-BL	83501	835B
82408	691FB	82645	482CY	82726	878067	82861	492DA	83028	467JX-GY	83502	835C
82409	692E	82646	990K	82727	878068	82862	470EF	83029	467JX-TL	83503	835D
82410	442057	82647	481KH	82728	462CF	82863	455DP	83030	490ACB-WH	83504	835E
82411	355B	82648	481KJ	82729	462CA	82864	490TY	83031	490ACB-RD	83505	835F
82413	878048	82649	481KK	82730	467JM	82865	460ER	83032	490ACB-PR	83506	835H
82414	479BL	82650	481KL	82731	467HZ	82866	465NX	83033	490ACB-BL	83507	835K
82459	873041	82651	481KM	82732	467JA	82867	465NY	83034	490ACB-GY	83508	835L
82471	457CJ	82655	481KX	82733	457CE	82868	460EP	83035	490ACB-TL	84486	497AK
82472	457CK	82656	482DM	82734	457CF	82869	878063	83036	481LE-WH	84000	463P
82473	462CK	82658	482DL	82735	457CH	82870	878064	83037	481LE-RD	84001	463R
82474	462CL	82659	481LC	82736	338JY	82871	551AZP	83038	481LE-PR	84002	468AF
82475	490ABY	82660	481LD	82737	338JZ	82872	550ZR	83039	481LE-BL	84003	468AH
82476	490ABZ	82661	482DN	82738	474CL	82873	481JA	83040	481LE-GY	84004	468AY
82477	467JS	82662	482DP	82739	467JL	82875	338JL	83041	481LE-TL	84005	468AJ
82478	467JT	82663	550ABA	82740	467JN	82876	490XS	83042	462CB-WH	84006	468AK
82479	491FN	82664	550ABB	82741	490ABP	82877	490XT	83043	462CB-RD	84007	458H
82480	491FP	82665	550ABC	82742	490ABL	82878	490XW	83044	462CB-PR	84008	457L
										84009	490XH





82218



82219



82220



82221

**BOX KITS**

Complete kit boxes designed for attractive store display or easy shelf storage.

**Each kit includes:**

- Ready to install gauges
- Matched senders for electrical gauges
- Tubing kits for mechanical gauges
- Installation hardware and lighting
- Complete installation instructions

**82218 DELUXE**

550BP	Mechanical Speedometer 3 3/8"
82170	Electrical Tachometer 3 3/8"
82305	Electrical Oil Pressure 2 1/16"
82307	Electrical Water Temperature 2 1/16"
82303	Fuel Gauge 2 1/16"
82309	Voltmeter 2 1/16"
279B-F	Pressure Sender
280ED-F	Temperature Sender
385C-F	Fuel Sender

**82219 TRACK FORCE**

82822-P	Electrical Tachometer 5"
82827-P	Mechanical Oil Pressure 2 5/8"
82829-72P	Mechanical Water Temperature 2 5/8"
82553-F	Tubing Kit (1)

**82220 TRACK FORCE**

82826-P	Mechanical Fuel Pressure 2 5/8"
82827-P	Mechanical Oil Pressure 2 5/8"
82829-72P	Mechanical Water Temperature 2 5/8"
82553-F	Tubing Kit (2)

**82221 DELUXE**

82405	Mechanical Fuel Pressure 2 5/8"
82406	Mechanical Oil Pressure 2 5/8"
82409-72	Mechanical Water Temperature 2 5/8"
82553-F	Tubing Kit (2)

**82824 COUNTER DISPLAY**

Attractive counter display constructed of durable PVC foam. Display features five 2 1/16" and one 3 3/8" mounting holes for Stewart Warner products. Display is gray with blue graphics and Wings logo. (Gauges not included).



82824









Gauge Type	Track Force								Wings			
	Dial	2 1/16" Diameter				2 5/8" Diameter				Dial	2 1/16" Dia.	
		Mechanical		Electrical		Mechanical		Electrical			Mech.	Elec.
		Black	S. Steel	Black	S. Steel	Black	S. Steel	Black	S. Steel			
<b>Ammeter</b>	60-0-60			82855-P	82875-P			82805-P	82825-P			
<b>Voltmeter</b>	10-16V			82862-P	82882-P			82812-P	82832-P	10-16 V (white)		82481
										10-16 V (black)		82482
<b>Pressure</b>	0-16			82868-P	82888-P					0-80 psi		
	1-15 psi					82806-P	82826-P			White		82473
	1-16 psi	82856-P	82876-P							Black		82474
	0-100 psi			82865-P	82885-P							
	5-100 psi	82857-P	82877-P			82807-P	82827-P			White	82475	
	10-200 psi		82858-P	82878-P			82808-P	82828-P		Black	82476	
										0-150 psi		
										White	82487	
										Black	82488	
										2-100 psi		
									White	82483		
									Black	82484		
<b>Temperature</b>	100-265°F	82859-P	82879-P			82809-P	82829-P			100-240°F		
	100-280°F			82866-P	82886-P					White		82477
	140-320°F			82867-P	82887-P					Black		82478
	140-325°F	82860-P	82880-P			82810-P	82830-P					
										140-320°F		
										White		82489
										Black		82490
										100-265°F		
										White	8279-72	
										White	82479-96	
									White	82479-144		
									Black	82480-72		
									Black	82480-96		
									Black	82480-144		
<b>Pyrometer</b>										300-1500°F		
										White		82485
										Black		82486
<b>Hourmeter</b>												
<b>Vacuum</b>	0-30 Hg	82861-P	82881-P			82811-P	82831-P			0-40 psi/0-30 Hg		
	0-30 Hg/0-15 psi	82864-P	82884-P							White	82491	
	0-30 Hg/0-40 psi					82814-P	82834-P			Black	82492	
<b>Fuel Level</b>	E-1/2-F 240 ohm			82863-P	82883-P			82813-P	82833-P	E-1/2-F 240 ohm		
	E-1/2-F 90 ohm			82869-P	82889-P					White		82471
	E-1/2-F 73 ohm			82870-P	82890-P					Black		82472
<b>Bow Trim</b>												
<b>Air Restriction</b>												
<b>Speedometer</b>			<b>3 3/8"</b>	<b>3 3/8"</b>							<b>3 3/8"</b>	<b>3 3/8"</b>
	0-160 mph		82852-P	82872-P						0-80 mph		
										White	82665	
										Black	82666	
										0-120 mph		
										White		82669
										Black		82670
										0-160 mph		
										White	82663	
										Black	82664	
									White		82661	
									Black		82662	
<b>Tachometer</b>					<b>2 1/2"</b>					0-3500 rpm		<b>3 3/8"</b>
	0-8000 rpm				82854-P					White		82671
		<b>3 3/8"</b>	<b>3 3/8"</b>	<b>3 3/8"</b>	<b>3 3/8"</b>	<b>3 3/8"</b>	<b>3 3/8"</b>	<b>5"</b>	<b>5"</b>	White		82673
	0-10000 rpm	82851-P	82871-P	82853-P	82873-P	82801-P	82821-P			Black		82672
	0-10000 rpm			82850-P	82873-P			82803-P	82823-P	Black		82674
	0-10000 rpm							82800-P	82820-P	0-8000 rpm		
	0-12000 rpm							82802-P	82822-P	White		82659
									Black		82660	

Part No.	Page No.	Part No.	Page No.	Part No.	Page No.	Part No.	Page No.	Part No.	Page No.
		362BB-D	24	550KM	10, 31	72408-11	28	77343-9	25
130B114D	41	362BC-D	24	551AHK-D	11	72446-F	37	77343-17	25
130B81D	41	362BD-D	24	551AHL-D	11	72530-23	28	77343-28	25
235A-D	38	362CZ-D	24	551AKM-D	11	72540-11	28	77861-49	28
235B-D	38	364K-F	24	558-M	26, 27	72541-11	28	78142	25
279A	23	364L-F	24	666	45	72542-11	28	78143	25
279B-F	23	366ACM	30	777	44	72543-11	28	78144	25
279C	23	366ACN	30	3322-M	28	72544-11	28	78145	25
279D	23	366ACY	35	3888-M	26	72545-11	28	78146	25
280EA	24	366ADB	39	13600-01	40	72573-11	28	78147	25
280EC	24	366CH	36	13610-01	40	72656-23	28	78148	25
280ED-F	24	366FK-F	36	13909	42	72666-23	28	78149	25
280EE-F	24	366HM-F	37	15513-01	40	72715-23	28	78150	25
284A	18	366LP-F	22	15550-01	40	72716-23	28	78151	25
284AA	18	366MP-F	32	15570-01	40	72717-23	28	78152	25
284AB	18	366NK	37	15571-01	40	72718-23	28	78153	25
284AD	18	366ST-F	37	20001-17	27	72719-15	28	78154	25
284AE	16	366SX	36	20007-17	27	72720-15	28	78155	25
284AF	15	366SX24	36	20016-14	27	72728-15	28	78628	25
284AH	9	366SZ	36	20017-17	27	72769	29	78630	25
284AJ	17	366TJ	40	20018-17	27	72774-11	28	78632	25
284AM	16	366WL	31	20019-17	27	72801-11	28	78634	25
284B	8	368P-D	31	20028-17	27	73468-11	28	78711	25
284BF	9	370T-D	40	20029-17	27	73469-11	28	78856-11	28
284BP	19	385AB-P	22	20034-17	27	73470-11	28	78869	42
284BR	19	385B-F	22	20035-17	27	73620-01	28	79380	25
284BS	19	385C-F	22	20036-17	27	73761-11	28	79550	29
284C	8	386AB-P	22	20037-17	27	73762-11	28	80364	29
284D	6	386B-F	22	20042-14	27	73763-11	28	80413	29
284H	17	386C-F	22	20085-17	27	73764-11	28	80470	29
284J	15	391A-F	22	20115-23	27	73804-11	28	80510	29
284L	16	391B-F	22	20116-23	27	74001-11	28	82050	38
284M	19	391C-D	22	20468-100	41	74041-01	28	82051	38
284N	7	391D-D	22	23944	26, 27	75109-11	28	82052	38
284P	7	391PX-D	22	26502	25	75237-11	28	82054	38
284R	7	392A-F	22	26503	25	75251-11	28	82055	38
284S	7	392B-F	22	32912	42	76051	25	82057	38
284T	17	392C-D	22	33710	42	76052	25	82095	41
286A	32	392D-D	22	37683	42	76053	25	82108	18
287A	32	400FL	40	39041	42	76054	25	82109	18
288A	32	403FL	40	60457	42	76055	25	82110	18
289B	32	457CR	19			76061	25	82111	19
289C	32	458H	20	63317	42	76062	25	82112	17
289D	32	462CS	17	63684	42	76063	25	82113	16
289E-F	32	462CT	17	64339	42	76064	25	82114	15
289F-F	32	463P	20	65002	42	76065	25	82115	15
289H-F	32	463R	20	65658	42	76071	25	82116	16
329-M	27	468AF	20	66001	42	76072	25	82117	9
329-M	26	468AH	20	69930	43	76073	25	82120	7
334AA-D	24	468AJ	20	70510-11	28	76074	25	82121	7
334AB-D	24	468AK	20	70729-11	28	76075	25	82124	19
334AD-D	24	468AY	20	70744	29	76575	25	82130	6
334H-D	24	475L	20	71017-11	28	76576	25	82136	17
334K-D	24	486-M	26	71723-23	28	76577	25	82152	10
334L-D	24	490XH	20	71791-11	28	76578	25	82153	10
334M-D	24	491CT	8	71792-11	28	76579	25	82162B	13
334N-D	24	535AH-D	11	71794-11	28	76580	25	82163	13
334P-D	24	535AK-D	11	71898-11	28	77342-4	25	82164B	13
334R-D	24	550ABE	10	71902-11	28	77342-9	25	82165	13
362AH-D	24	550BP-D	10	71915-11	28	77342-17	25	82170	13
362AJ-D	24	550HF-D	10	72030	23	77342-28	25	82171	13
362AN-D	24	550HH-D	10	72108-15	28	77343-4	25	82171B	13



Part No.	Page No.	Part No.	Page No.	Part No.	Page No.	Part No.	Page No.	Part No.	Page No.
82200	18	82346	17	82481	17	82636	12	82728	16
82201	18	82347	17	82482	17	82637	14	82730	15
82202	18	82349	16	82483	6	82638	33	82731	15
82207	6	82350	7	82484	6	82640	12	82732	15
82208	6	82351	15	82485	14	82641	12	82733	19
82209	6	82352	15	82486	14	82642	14	82734	19
82210	8	82353	19	82487	7	82643	12	82735	19
82211	19	82354	16	82488	7	82644	12	82736	18
82212B	36	82355	15	82489	15	82645	14	82737	18
82213B	36	82357	14	82490	15	82646	39	82738	17
82214B72	36	82358	16	82491	9	82647	12	82739	15
82215B	36	82359	18	82492	9	82648	13	82740	15
82216B	36	82360	18	82493	19	82649	13	82741	6
82217B	36	82361	18	82494	19	82650	13	82742	7
82218	53	82363	6	82495	19	82651	12	82743	7
82219	53	82364	7	82496	19	82656	14	82744	8
82220	53	82365	7	82501	23	82658	14	82745	9
82221	53	82371	7	82503	24	82659	13	82746	7
82222	35	82372	6	82504F	23	82660	13	82749	8
82223	35	82373	7	82505	14, 24	82661	14	82800-P	13
82224	35	82374	15	82510-F	24	82662	14	82801-P	11
82225	35	82375	15	82512	37	82663	10	82802-P	13
82226	35	82376	17	82514	23	82664	10	82803-P	13
82227	35	82377	17	82530	34	82665	10	82805-P	18
82228	35	82378	19	82531	34	82666	10	82807-P	6
82229	35	82379	19	82532	34	82669	14	82808-P	7
82232	34	82380	7	82533	34	82670	14	82809-P	8
82233	34	82381	8	82550	36	82671	12	82810-P	8
82243	34	82382	8	82551	36	82672	12	82811-P	9
82244	34	82383	9	82553-F	37	82673	12	82812-P	17
82301	9	82384	9	82556-1	14	82674	12	82813-P	19
82303	19	82386	19	82556-2	14	82676	10	82814-P	9
82304	16	82387	16	82556-3	14	82677	10	82815	53
82305	16	82388	17	82561-F	37	82678	10	82820-P	13
82306	15	82389	15	82562-F	37	82680	10	82821-P	11
82307	15	82390	15	82563B	36	82681	31	82822-P	13
82308	15	82391	17	82564B	36	82682	31	82823-P	13
82309	17	82392	6	82565-F	39	82688	11	82824	53
82310	18	82393	7	82572	37	82689	11	82825-P	18
82311	18	82394	8	82573	37	82690	11	82827-P	6
82313	18	82395	8	82574	37	82691	11	82828-P	7
82320	6	82396	6	82600	14	82692	10	82829-P	8
82321	6	82397	17	82601	12	82694	10	82830-P	8
82322	6	82398	18	82603	14	82695	10	82831-P	9
82323	6	82404	18	82604	14	82696	11	82833-P	19
82324	7	82406	6	82605	20	82697	10	82834-P	9
82325	7	82407	7	82606	20	82698	14	82835-P	17
82326	8	82409	8	82612	34	82700	18	82850-P	13
82327	8	82410	8	82618	33	82701	18	82851-P	11
82328	9	82411	9	82619	12	82702	15	82852-P	10
82329	7	82413	19	82620	12	82703	8	82853-P	33
82331	7	82459	31	82622	12	82704	6	82854-P	33
82332	7	82460	9	82623B	39	82705	16	82855-P	18
82333	16	82471	19	82624	39	82706	15	82857-P	6
82334	14	82472	19	82625	39	82708	15	82858-P	7
82335	14	82473	16	82626	39	82709	17	82859-P	8
82336-96	31	82474	16	82628	33	82710	7	82860-P	8
82340	9	82475	6	82629	39	82712	19	82861-P	9
82341	19	82476	6	82630	39	82713	18	82862-P	17
82342	19	82477	15	82631	39	82714	16	82863-P	19
82343	18	82478	15	82632	39	82715	15	82864-P	9
82344	15	82479	8	82633	12	82717	7	82865-P	16
82345	15	82480	8	82635	12	82718	9	82866-P	15

Part No.	Page No.	Part No.	Page No.	Part No.	Page No.	Part No.	Page No.	Part No.	Page No.
82878-P	7	83056	19	94354	43	816647-100	41	832855D	37
82879-P	8	83057	19	95115	42	817759	42	833805-100	41
82880-P	8	83058	19	95374	43	817767	42	835251D	37
82881-P	9	83059	19	95527	37	817769	42	836092	23
82882-P	17	83060	10	96127	42	817825-F	32	873128	30
82883-P	19	83061	10	96798	31	818749	42	873129	30
82884-P	9	83062	10	96799	31	818750	42	873134	34
82885-P	16	83063	10	96833	42	819468	42	873135	34
82886-P	15	83064	10	98578-100	41	820152	42	873136	34
82888-P	16	83065	10	98877	42	820153	42	873137	34
82889-P	19	83066	37	98984	42	820210-2	43	873138	34
82890-P	19	83067	16	101254	42	820210-4	43	873139	34
82891	22, 23	83068	16	101983	42	820211-1	43	873140	34
82892	23	83069	16	104461	42	820211-2	43	873141	34
82893	23	83070	16	105133	42	820211-13	43	873142	34
82894	23	83071	16	136374-6T	41	820213-3	43	873143	34
82895	23	83072	16	137374-10T	41	820214-1	43	873144	34
82896	14	83300	24	400211	42	820214-2	43	873145	34
82897	23	83301	24	400514	43	820214-4	43	873158	30
82901	45	83302	24	402210	42	820214-6	43	873159	30
82903	44	83303	24	405137	42	820215-1	43	876042	30
82951	45	83304	24	406908	42	820219-1	42	876043	30
82953	44	83305	24	407010-F	39	820219-2	42	876052	30
82954	45	83306	24	407616	39	820220-1	42	876053	30
82954	44	83307	24	408550-D	37	820346-1	43	878089	30
83006	19	83308	24	408758	42	820346-11	43	878090	30
83007	19	83309	24	409353	42	820346-12	43	878096	30
83008	19	83310	24	411290	23	820346-16	43	878097	30
83009	19	83311	24	411335-D	39	820346-22	43	880123	30
83010	19	83312	24	412850	31	820346-23	43	880124	30
83011	19	83313	24	412850-1	31	820346-4	43	880137	30
83012	17	83314	24	413717	39	820500-3	43	880138	30
83013	17	83500	21	414676	42	820500-4	43	883106	30
83014	17	83501	21	414677	42	820500-7	43	883107	30
83015	17	83502	21	415996	42	820500-11	43	883116	30
83016	17	83503	21	418035	42	820733-3	43	883117	30
83017	17	83504	21	418614	41	820733-10	43	84000	20
83018	16	83505	21	418615	41	820733-33	43	84001	20
83019	16	83572	37	418811	42	820734-5	43	84002	20
83020	16	83573	37	420125-F	40	820734-6	43	84003	20
83021	16	85004-25	26	421643	42	821146-1	43	84004	20
83022	16	85008-25	26	421795	42	821211-4	43	84005	20
83023	16	85010-25	26	425451	42	822650D	37	84006	20
83030	6	85013-12	26	426056	42	822651D	37	84007	20
83031	6	85014-02	26	426106	42	822652D	37	84008	20
83032	6	85015-03	26	426108	42	823114	42	84009	20
83033	6	85017-03	26	427828	42	823813	43		
83034	6	85019-03	26	428819-F	37	824012	43		
83035	6	85021-03	26	428827	42	824520D	37		
83036	13	85023-25	26	429354	23	824521D	37		
83037	13	85093-03	26	439361-F	22	824522D	37		
83038	13	85094-12	26	439362-F	22	825104-D	40		
83039	13	85097-02	26	439363-D	22	825612D	37		
83040	13	85098-03	26	439364-D	22	825128	41		
83041	13	85104-25	26	810809	43	829525-2D	36		
83042	16	85126-03	26	811192	42	829525-6D	36		
83043	16	85127-12	26	811653-F	32	829525-8D	36		
83044	16	85133-03	26	811659-F	32	829525-9D	36		
83045	16	85134-02	26	813489	39	830346-17	43		
83046	16	85135-03	26	813642-F	32	830540	30		
83047	16	85342-03	26	813783-100	41	832353D	37		
83054	19	90567	37	813877-F	32	832354D	37		
83055	19	94353	43	814143-F	32	832603D	37		



# Stewart Warner

## 98000 SERIES LCD HOURMETERS

**Ruggedly built & fully sealed digital units fit virtually any application**

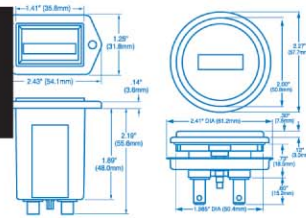

### DESCRIPTION:

Rugged, reliable units are ideal for O.E.M. and fleet applications ■ Proven LCD hourmeter module with superior accuracy ■ Standard ranges 9-64 VDC ■ Fully sealed & dust-proof ■ Fits in existing panel openings for easy installation ■ Large easy-to-read displays with six digits registering up to 99,999.9 hours ■ Protected from potentially damaging transient voltage and EMI ■ Low power consumption ■ Run indicator (pixel format) to verify timing function ■ Compact design simplifies packaging ■ No battery back-up required (10-year memory without power) ■ Resettable four-terminal versions available ■ U.L., CE & CSA approvals pending

### SPECIFICATIONS:

Dimensions:	~ 2.27" outside diameter for round hourmeter (overall); ~ 2.13" x 1.25" for mini-hourmeter (overall; hexagonal shape); case depth .75" (round and mini), overall depth 1.35" (from behind bezel, with terminals).
Panel opening:	~ 2.0" mounting hole for round; ~1.45" x .95" for mini (Note: Holes for mini-hourmeter are .150" in diameter and spaced 1.750" apart).
Lens:	Glass lens for round hourmeter; polycarbonate lens for mini-hourmeter.
Bezel:	Chrome-plated (round); black, matte finish polycarbonate housing/bezel assembly for mini-hourmeter.
Display/digits:	Six digits (99,999.9 hours); 6 mm digit height.
Run indicator:	Pixel flashes on timing sequence of three seconds on & one second off; gray/black color; universal hourglass symbol.
Movement/accuracy:	+/- .02% over operating temperature range.
Voltage range:	9-64 VDC (consult with factory for applications requiring more than 64VDC ).
Power draw:	< 1mA at 12 VDC (power terminal).
Input protection:	Reverse polarity, load dump & EMI.
Connections/installation:	Integral 1/4" blade terminals (3/16" blade terminals are optional); two (2) or four (4) terminal configurations (Note: Four-terminal configurations are resettable via terminal #4 to zero).
Sealing:	Fully sealed to IP 67 (moisture & dust).
Operating temperature:	-40°C to +85°C.
Vibration/shock:	Tested to 20 g's vibration & 55 g's shock per SAE J1378; tested to 10 g's vibration & 55 g's shock per MIL-M-3971D.
Memory storage:	Minimum 10 years (without being powered).
Options:	Other Hobbs bezels and dial artwork (consult with factory)

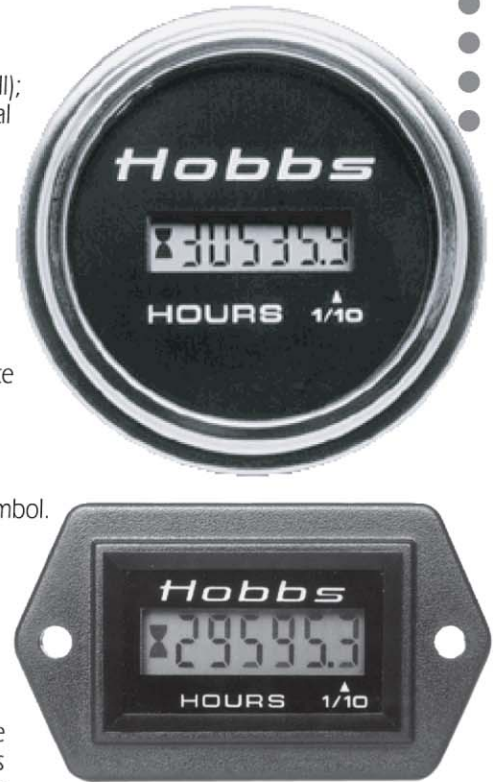

### APPLICATIONS:

Suitability of application is the responsibility of the user. Standard products should work in most applications. Consult with factory for use in machines that generate vibration and shock profiles that exceed rated specifications.

